

# SS4-Gen2 User Manual



## 4CH 1080P MDVR

Thank you for using our mobile DVR. Please read this user's manual carefully to ensure that you can use the device correctly and safely.

The contents of this manual are subject to change without notice.

V1.5

# Contents

|  |    |
|--|----|
| 1 Specifications .....                                     | 1  |
| 2 Precautions .....  | 3  |
| 3 Main Features .....                                      | 4  |
| 4 Wiring Diagram .....                                     | 6  |
| 5 Connection - Front Panel .....                           | 7  |
| 5.1 Mechanical lock .....                                  | 8  |
| 5.2 LED .....  | 8  |
| 5.3 Remote Controller .....                                | 8  |
| 5.4 SSD Slot .....   | 9  |
| 5.5 SD Card Slot .....                                     | 9  |
| 5.6 USB Slot .....   | 9  |
| 6 Connection - Back Panel .....                            | 9  |
| 6.1 Power .....  | 9  |
| 6.2 Cameras (AVIN 1~4) .....                               | 10 |
| 6.3 LCD Monitor .....                                      | 11 |
| 6.4 Buzzer .....   | 12 |
| 6.5 Alarm, Speed Interface .....                           | 12 |
| 6.6 Panic Button and Its Conversion Cable (Optional) ..... | 14 |
| 6.7 Four-in-one Antenna (GPS, 2G/3G/4G, Wi-Fi) .....       | 16 |
| 7 Menu .....   | 17 |
| 7.1 Menu Introduction .....                                | 17 |
| 7.2 Menu Lock .....  | 18 |

|  |    |
|--|----|
| 7.3 Keyboard Operation Instruction ..... | 20 |
| 7.4 Manual Recording .....               | 22 |
| 7.5 Playback .....                       | 22 |
| 7.6 Log .....                            | 27 |
| 7.7 Display Mode Switching .....         | 27 |
| 7.8 System .....                         | 27 |
| 7.9 Disk .....                           | 28 |
| 7.10 Volume .....                        | 29 |
| 8 Record Setup .....                     | 30 |
| 8.1 Power On Rec. ....                   | 30 |
| 8.2 Cyclic Rec. ....                     | 30 |
| 8.3 Event Rec. ....                      | 30 |
| 8.4 Video Quality .....                  | 31 |
| 8.5 Record Channel .....                 | 34 |
| 8.6 IPC Setup .....                      | 34 |
| 8.7 Event Duration .....                 | 37 |
| 8.8 File Length .....                    | 37 |
| 8.9 Motion Sensitivity .....             | 38 |
| 8.10 G-Sensor Sensitivity .....          | 38 |
| 8.11 File Type .....                     | 45 |
| 8.12 Record Audio .....                  | 45 |
| 9 Display .....                          | 46 |
| 9.1 Camera Display Setting .....         | 46 |

|   |    |
|---|----|
| 9.2 Camera Name Setting .....             | 47 |
| 9.3 System Language Setting .....         | 47 |
| 9.4 Audio Out .....                       | 48 |
| 9.5 OSD Display Setting .....             | 48 |
| 9.6 Menu On .....                         | 49 |
| 9.7 Speed .....                           | 49 |
| 9.8 GPS .....                             | 50 |
| 9.9 Mirror .....                          | 51 |
| 9.10 System Format Setting .....          | 52 |
| 9.11 Radar Setting .....                  | 53 |
| 10 Network .....                          | 60 |
| 10.1 LAN and Server Setting .....         | 61 |
| 10.2 Wi-Fi Network and Server Setup ..... | 62 |
| 10.3 2G/3G/4G Control and Setup .....     | 64 |
| 10.4 AP Internet Setup .....              | 66 |
| 10.5 Network Status .....                 | 66 |
| 10.6 Server .....                         | 67 |
| 10.7 File Upload .....                    | 68 |
| 10.8 RTSP Streaming .....                 | 72 |
| 11 System .....                           | 73 |
| 11.1 Log in Setup .....                   | 73 |
| 11.2 License Plate Number Setup .....     | 73 |
| 11.3 System Time Setup .....              | 74 |

|  |     |
|--|-----|
| 11.4 Scheduled Recording .....                 | 77  |
| 11.5 Exception .....                           | 77  |
| 11.6 ACC Settings .....                        | 78  |
| 11.7 Alarm Information Setting .....           | 79  |
| 11.8 Update .....                              | 82  |
| 11.9 Configuration .....                       | 84  |
| 11.10 Application Setting .....                | 85  |
| 11.11 System Info .....                        | 98  |
| 12 FAQ .....                                   | 98  |
| 13 APPENDIX .....                              | 99  |
| APPENDIX I : Abbreviation & Description .....  | 99  |
| APPENDIX II : Accessories .....                | 100 |
| APPENDIX III: Compatibility Storage List ..... | 101 |

# 1 Specifications

| 4CH 1080P DVR                |                     |   |
|------------------------------|---------------------|---|
| System                       | Operating system    | Linux   |
|                              | Operating interface | Graphical menu operation interface (OSD)                  |
|                              | Video permission    | Administrator & user setting                              |
| Video                        | Video input         | 4 x 1080P analog high definition                          |
|                              | CVBS output         | 1CH 6pin aviation connector output PAL/NTSC               |
|                              | Video display Mode  | Single/Split/Triple/Quad/8 Cam/9 Cam/Black screen display |
|                              | Video standard      | PAL: 25fps, NTSC: 30fps                                   |
|                              | Compression         | H.264 main profile  |
| Audio                        | Audio input         | 4 channels  |
|                              | Audio output        | 2 channels  |
|                              | Record format       | Synchronized video & audio recording                      |
|                              | Audio compression   | ADPCM   |
| Digital processing & storage | Image resolution    | Max 4 x 1080P(1920 x 1080)                                |
|                              | Video bitrate       | 64kbps~4Mbps/channel                                      |
|                              | Storage             | 56~1800MB/(channel/hour)                                  |
|                              | Audio bitrate       | 32kbps  |
|                              | Storage             | SD card x 1, SSD x 1                                      |
| Alarm                        | Alarm input         | 6 channels  |
|                              | Alarm output        | 2 channels, 1 buzzer                                      |
|                              | Motion detection    | High/Low/Off sensitivity adjustable                       |
| Interface for communication  | IR                  | 1 channel   |
|                              | RS232               | 1 channel   |
|                              | RS485               | 1 channel   |
|                              | CAN                 | 2 channels  |
|                              | RJ45                | 1 channel   |

|                      |                            |                          |
|----------------------|----------------------------|--------------------------|
|                      | USB2.0                     | 1 channel                |
| Wireless             | 2G / 3G / 4G               | Optional                 |
|                      | Wi-Fi                      | Optional                 |
|                      | Wi-Fi hotspot / AP         | Optional                 |
| GPS                  | Optional                   |                          |
| G-Sensor / Gyroscope | 3 axis sensor              | Available                |
| Software             | Windows client             | Available                |
|                      | iOS client                 | Available                |
|                      | Web portal                 | Available                |
| Power                | Input                      | 10~32V                   |
|                      | Output                     | 12V@4A                   |
|                      | Max Power Consumption      | 48W                      |
|                      | Standby Power Consumption  | 100mW                    |
| Electrical           | Operating temp. / humidity | -20°C ~ +70°C / <80%     |
|                      | Super Capacitor            | Available                |
|                      | Clock                      | Built-in clock, Calendar |
|                      | algorithm                  | DMS/ADAS/BSD/AVM         |
| Others               | Waterproof grade           | IP69K                    |
|                      | Anti-vibration grade       | MIL-STD-810G             |

## 2 Precautions

- 1) Motion detection function is set to OFF by default. Alarm files will be created When the motion detection is set to “On”.
- 2) G-Sensor recording is recommended to set to “On” during driving for emergency recording use. G-Sensor level is optional.
- 3) If the device could not boot up, try to remove all storage disks from the device, and then restart it to check whether it could boot normally or not.
- 4) Should: ACC wire should be connected to the ignition wire, two VCC wires to the positive pole of the battery and two ground wires to the negative pole. Shouldn't: ACC and two VCC wires should not be connected to the ignition wire and two ground wires should not be connected to the negative pole of the battery, otherwise it may lead to the damage of the disk and the recording files. Prohibit: ACC and two VCC wires are prohibited to be connected to the positive pole of the battery and two ground wires to the negative pole. In this case, the battery would be run out quickly.
- 5) All the disks must be formatted on the device before they are put into use.
- 6) The users' name could not be changed, while the password is editable.
- 7) All types of video files including event recording files are overwritten by default.
- 8) The corresponding types of SENSOR-IN1~6 on the trigger line are as follows:

| SENSOR<br>-IN1  | SENSOR<br>-IN2 | SENSOR<br>-IN3 | SENSOR<br>-IN4 | SENSOR<br>-IN5    | SENSOR<br>-IN6 |
|-----------------|----------------|----------------|----------------|-------------------|----------------|
| ALARM INPUT 1~4 |                |                |                | Reversal<br>Input | Brake<br>Input |

- 9) The disk must be installed appropriately and well connected; otherwise the device would not work properly.
- 10) GPS antenna, 2G/3G/4G antenna, Wi-Fi antenna must be connected correctly and tightened up.
- 11) If DVR does not have GPS, WIFI and 4G, the time cannot be automatically calibrated, and the difference will be about 10min in a year.
- 12) If more accurate time is required, user needs to manually perform time calibration.



# 3 Main Features

## Controlled by touch screen

- All settings and operations could be done through a touch-control monitor.

## Video and Audio

- 4 x 1080P video inputs.
- 4 x audio inputs.
- 2 x audio outputs.
- 2 video outputs (1 x CVBS -6pin, 1 x VGA-1080P).

## Recording

- 4CH Video & Audio Recorder with image resolution up to 1920 x 1080, G-Sensor data and GPS data.
- Multiple recording modes: power on recording, normal recording, schedule recording and event recording (i.e., G-Sensor recording, Overspeed recording, Motion detection recording, Alarm recording 1~6 and Panic button recording, radar detection alarm recording, inappropriate drivers' action warning recording, driving safety risk recording, FCW detection alarm, DMS detection alarm, Lane departure warning alarm, BSD detection alarm), Cyclic recording and 15 seconds pre-recording are also supported.

Recording files are stored in the SSD or SD card.

- Real-time recording of license plate numbers, driving speed, G-Sensor/Gyroscope 3D accelerated speed, longitude and latitude, and GPS tracking.

## Preview and Playback

- Support simultaneous playback of audio and video for either a single channel or 4 channels..
- Support searching recording files by dates and recording types.
- Support dragging the time progress bar during video playback.
- Indicate recording status and alarm status etc.

## Storage Types

- Support 1 x SSD (2TB) and 1 x SD card (512GB, SDHC, SDXC).
- SSD is preferred. SD card could be put into use if there is no SSD connected/detected. SD card can be easily removed from DVR.

## Backup

- Support USB disk or USB hard disk to backup the recording files.

## Network

- Support LAN, Wi-Fi, and 2G / 3G / 4G.
- LAN, Wi-Fi and 2G / 3G / 4G have the sequence priority of connections. They are automatically switched to save the data once LAN, Wi-Fi or 2G/3G/4G is connected.
- Recording files could be uploaded to the server. Files are able to be searched/downloaded by CMS Client.
- Wi-Fi supports STATION and AP mode. Wi-Fi AP mode enables mobile devices to be connected, and users could use mobile devices to preview and configure conveniently.
- Support remote real-time video streaming and previewing.
- Support automatic upload of alarm recording files, alarm information, log information and GPS trajectory, which is convenient to analyze any abnormal conditions of the vehicle and track the vehicle.
- Support remote configuration and remote upgrading.
- Support PC Windows Client, mobile iOS and Android apps. Users could remotely monitor vehicles by computers or mobile phones.

## Alarm

- 6 channels of alarm inputs, 1 channel of buzzer output and 2 channels of alarm outputs.
- Overspeed alarm.
- Motion detection alarm.
- G-Sensor alarm.
- Panic button alarm.
- DMS alarm(no driver, fatigue, distraction, phone call, smoke, no mask, no seatbelt, sunglass).
- ADAS alarm (Forward collision warning, Pedestrian detection warning, Lane departure warning).
- BSD alarm.

## Security

- Users' password protection. The device could not be accessed without password.
- Support account management.

# 4 Wiring Diagram

- Output wiring the method of VGA display:

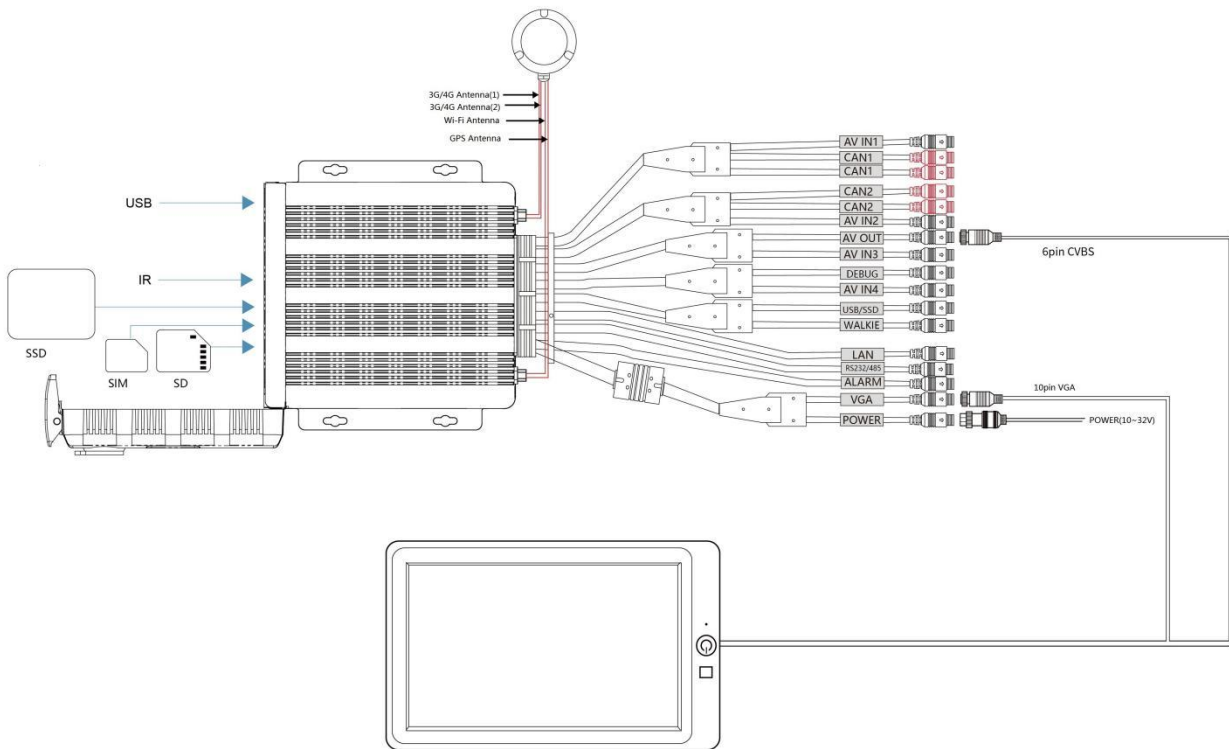

- Output wiring the method of CVBS/AHD display:

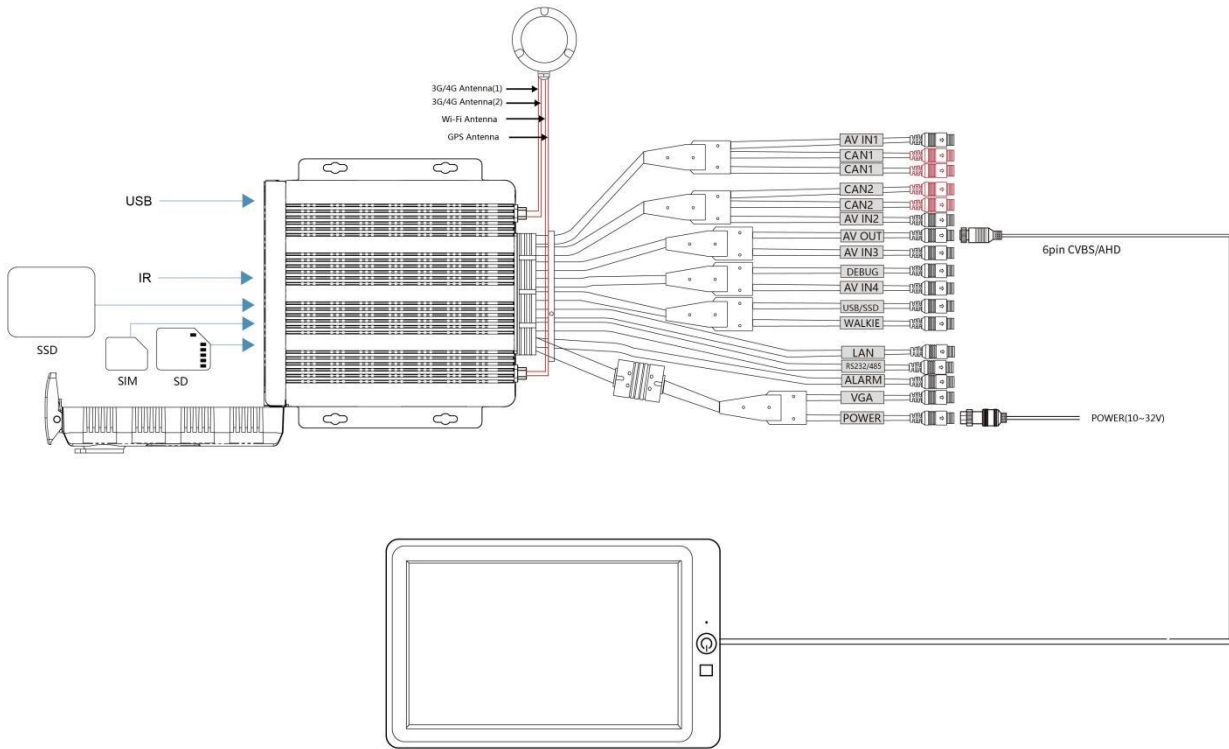

- Front and rear panel view:

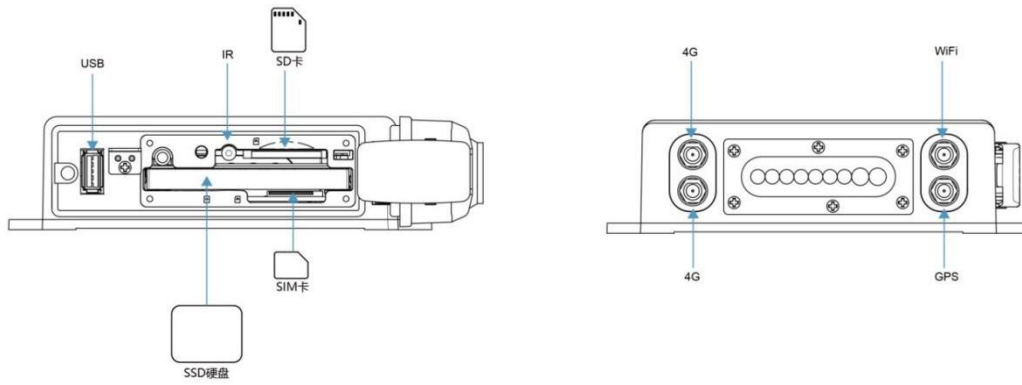

## 5 Connection - Front Panel

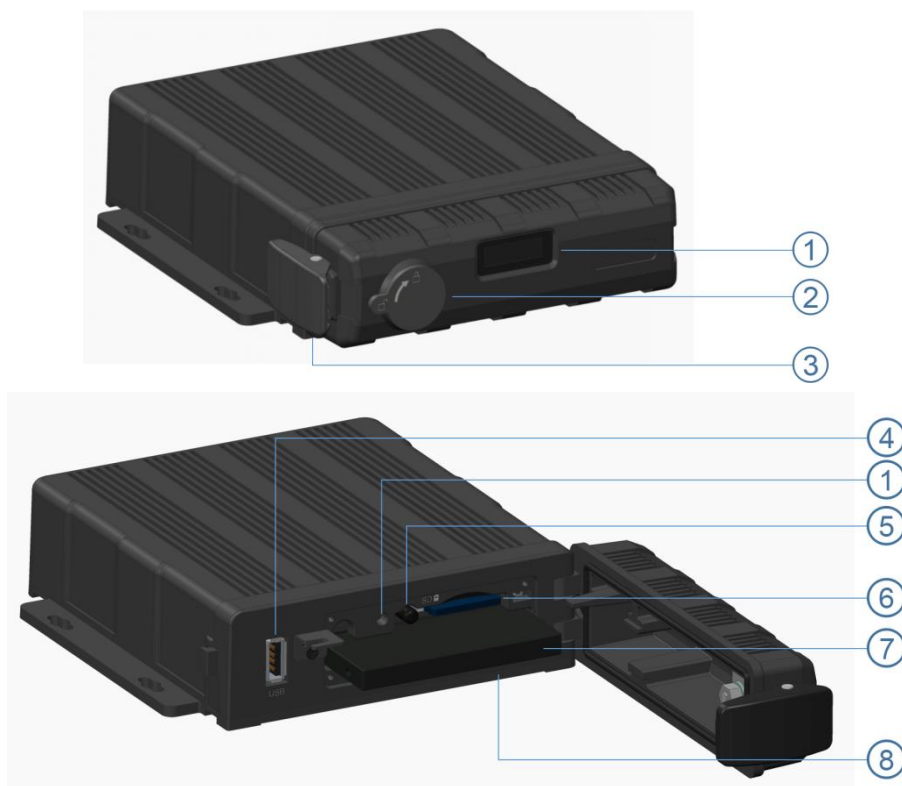

- |                   |                 |
|-------------------|-----------------|
| ① LED indicator   | ⑤ IR receiver   |
| ② Mechanical lock | ⑥ SD card slot  |
| ③ SSD lock cover  | ⑦ SSD slot      |
| ④ USB2.0 port     | ⑧ SIM card slot |

## 5.1 Mechanical lock

- Close the front cover, lock the buckle, and then lock the device with the key.
- The device will stop recording and the buzzer will beep when the front cover is open, If the front cover is still open or the electronic lock is not closed after 2 minutes, DVR will resume recording.

## 5.2 LED

- When DVR is working normally, the red light is always on and the green light is flashing.
- When upgrading the DVR firmware, the red light is on and the green light is off.

## 5.3 Remote Controller



Use the remote controller closer enough to the IR Receiver, otherwise it may not work.

| Description                                | Buttons |  |
|--|---------|--|
| Useless - reserved                         | POWER   |  |
| Switch to ch1~8 for single channel display | 1~8     |  |
| Switch to an eight-segment display         | 0       |  |
| Enter menu                                 | MENU    |  |
| Move up                                    | Up      |  |
| Move to left                               | Left    |  |
| Enter sub menu to set and confirm          | ENTER   |  |
| Useless - reserved                         | REC     |  |
| Move down                                  | Down    |  |
| Exit                                       | ESC     |  |
| Move to right                              | Right   |  |
| Useless - reserved                         | MULTI   |  |
| Clear input                                | CLEAR   |  |

## 5.4 SSD Slot

- 1 x SSD (Max. 2TB ).
- Size: 2.5 inches.

## 5.5 SD Card Slot

- 1x SD (Max. 256GB).
- Insert, remove the SD card.

Step 1: Use the key to unlock the device and open front cover.

Step 2: Insert SD card to SD card slot.

Step 3: Close the front cover and use the key to lock.

## 5.6 USB Slot

USB 2.0

# 6 Connection - Back Panel

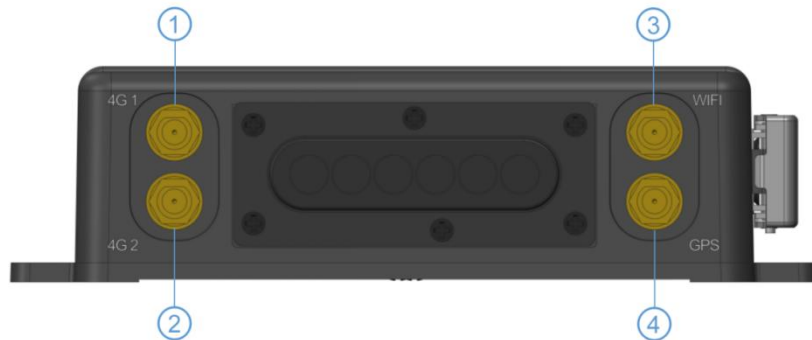

① 2G/3G/4G antenna 1

③ Wi-Fi antenna

② 2G/3G/4G antenna 2

④ GPS antenna

## 6.1 Power

- Power Input

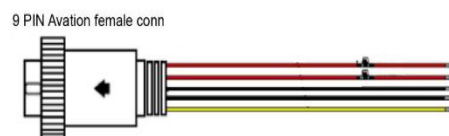

Connect the 9 PIN female to the 9 PIN male on the device.

- Connection Method

Connect ignition wire to yellow ACC, battery Positive to V+ (Red wire) and Negative to GND (black wire).

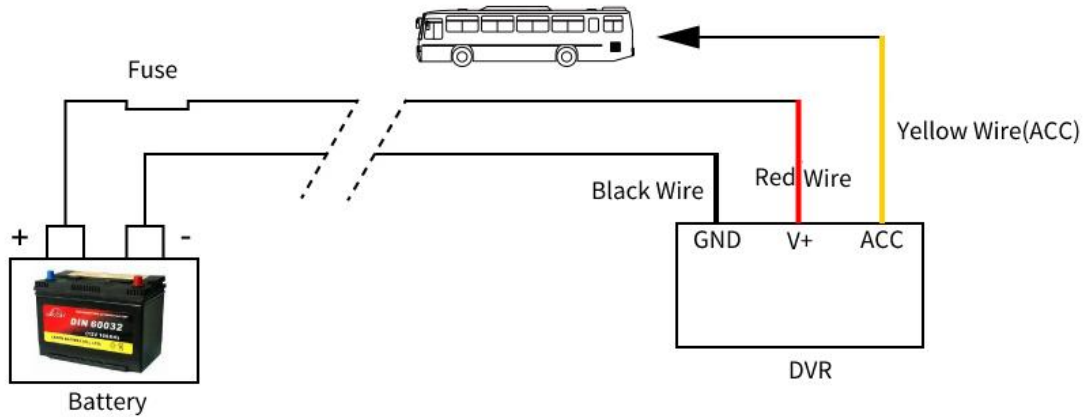

## 6.2 Cameras (AVIN 1~4)

- Below is the definition of camera input (male).

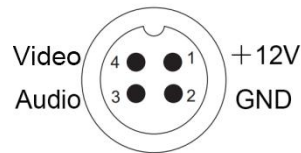

- How To Connect Cameras

Connect 4 cameras on below cable which connects to back plate of DVR

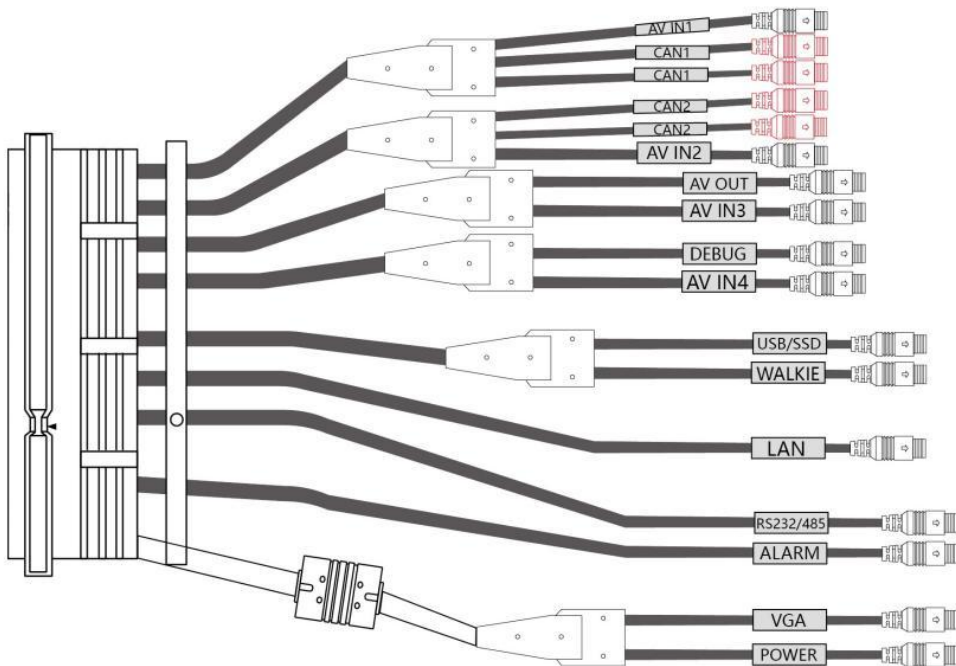

## 6.3 LCD Monitor

- High definition monitors are recommended to work with the device as below.



- The output resolution of the LCD monitor can be selected. Settings are as follows.

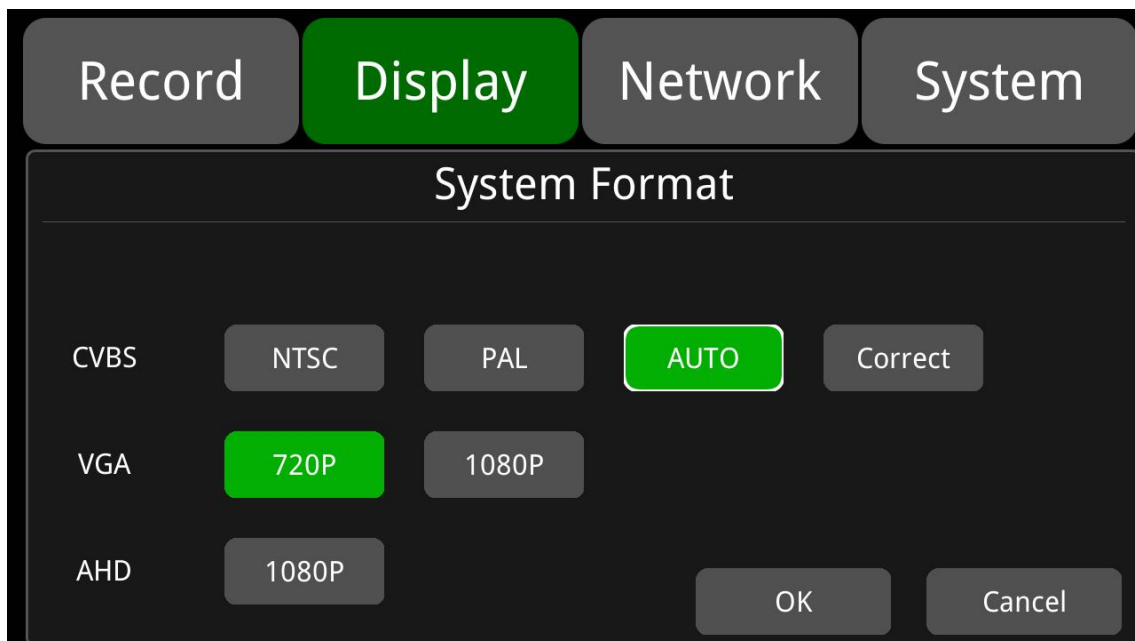

AUTO is defined as below.

| System Format  |            |       |
|----------------|------------|-------|
| CVBS           | VGA        | AHD   |
| NTSC/PAL/ AUTO | 1080P/720P | 1080p |



## 6.4 Buzzer

If the device is not connected to a monitor, please check the recording status by the buzzer.

The buzzer would alarm if the device is not recording under Normal Mode which is set by default. To stop the buzzer from alarming, please make sure the device is working properly.

The buzzer warning functions are as follows.

- The buzzer will keep beeping for a while for all types of alarm event recording.
- If the buzzer alarm is not needed, users can go to “System - Exception” page, and set Buzzer from “On” to “Off”. And please note that if the Buzzer is set to “Off”, there would be no alarm even if any event is triggered.

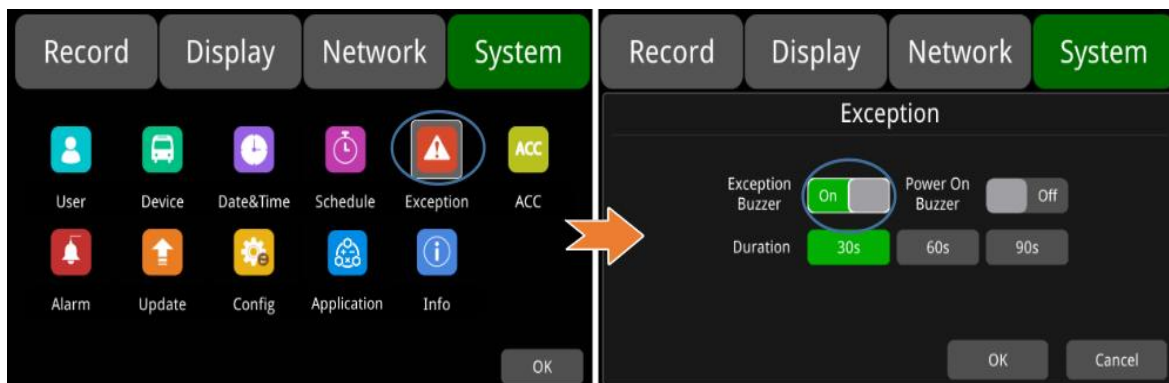

- Power On Buzzer: Power-on Buzzer: When it is set to ON, DVR will beep 15 times continuously when it is powered on; when it is set to OFF, there will be no beep from DVR during startup.

If the buzzer beeps intermittently, it means that the device is unable to record.

Different beeping modes stand for different working status as below.

- 1) The front cover is open: one long beep and one short beep.
- 2) No disk: one long beep and two short beeps.
- 3) If the disk is operating normally, the video file is full, and the Cyclic Rec. is off: two short beeps and one short beep.

## 6.5 Alarm, Speed Interface

- Alarm, Speed Interface Cable

See the figure below:



- Pin Definition

| 10 PIN     | 1             | 2             | 3            | 4            | 5            | 6            | 7            | 8            | 9      | 10     |
|------------|---------------|---------------|--------------|--------------|--------------|--------------|--------------|--------------|--------|--------|
| Color      | Red           | Pink          | Blue         | Grey         | White        | Purple       | Green        | Yellow       | Black  | Black  |
| Definition | Alarm out2    | Alarm out1    | Alarm _in6   | Alarm _in5   | Alarm _in4   | Alarm _in3   | Alarm _in2   | Alarm _in1   | GND    | GND    |
| Definition | Alarm output2 | Alarm output1 | Alarm input6 | Alarm input5 | Alarm input4 | Alarm input3 | Alarm input2 | Alarm input1 | Ground | Ground |

1) There are 6 alarm inputs including alarm inputs 1 ~ 4, reversal input, brake input, which can trigger the alarm recording. The cursor will be displayed when the alarm input channel is working. The first 4 ones can be self-defined by the user.

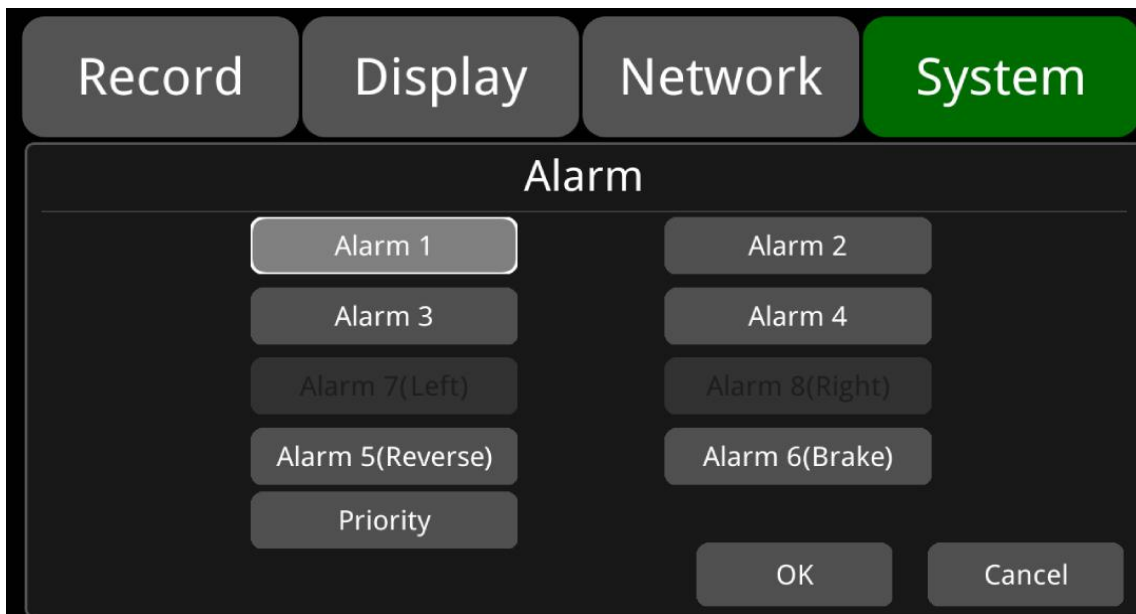

- 2) The voltage of alarm output 1 is 12V by default, which can be used as a trigger and needs to work together with alarm inputs. You can also set up the BUZZER as one output.
- 3) If Alarm input 1 is active and combined with Alarm output 1, the Alarm output 1 will output a high-level voltage to trigger other device.

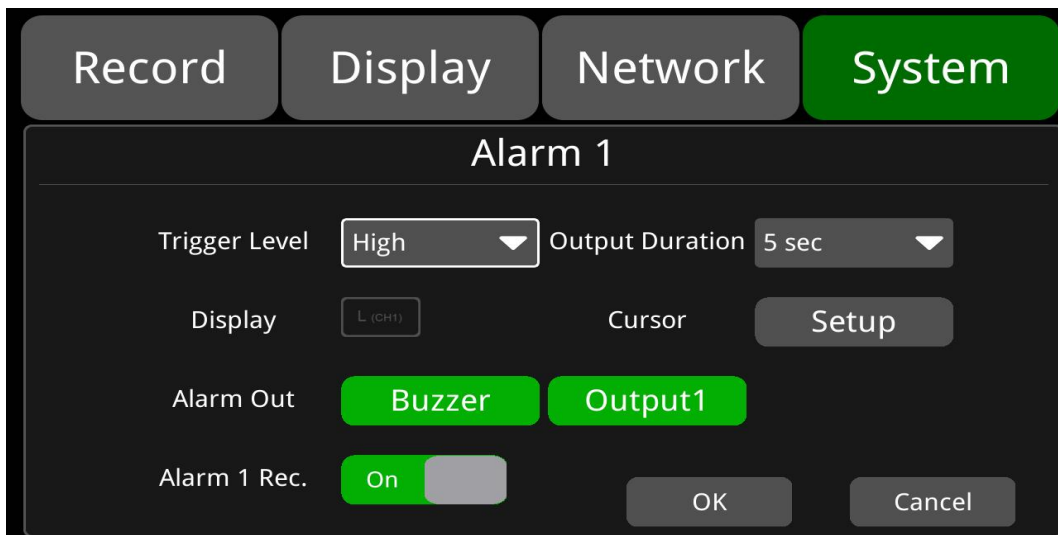

## 6.6 Panic Button and Its Conversion Cable (Optional)

- **Overview**

The LEDs are used to show the working status of the device. But when the device is installed in the vehicle, it is not easy to check the LED on the front panel. Each LED indicates the corresponding status of the device. Furthermore, the panic button makes it easier to trigger alarms and recording for emergencies by pushing a single button.

The panic button has four main features, including LED indicators, an emergency button, buzzer alarms and infrared functions.



- **Pin Definition**

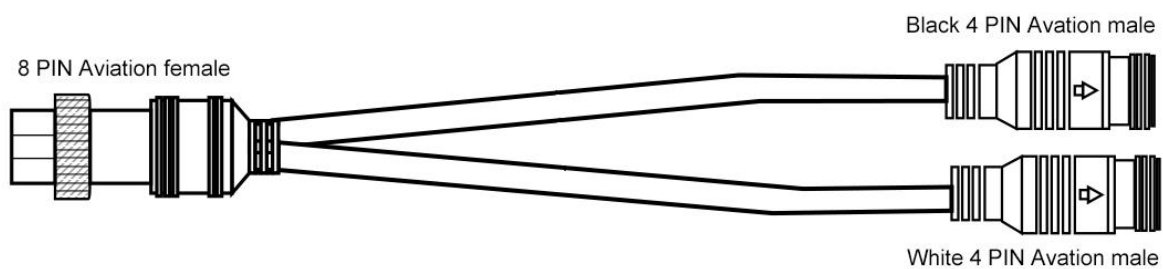

Connect the 8PIN aviation connector of the above cable to the 8PIN aviation connector on DVR (RS232 and RS485).

- **LED**

| LED   | Color   | ON   | OFF   |
|-------|---------|--|---|
| VLoss | Yellow  | Go to [Setting]-[Record]-[Record Channel] to see if any camera is missing. In case any camera is chosen but not connected, LED would show yellow | Normal operation  |
| Rec   | Green   | Starts to record   | No recording  |
| GPS   | Yellow  | GPS signal is lost   | Normal operation  |
| Mem   | Red     | Storage damage or No storage   | Normal operation  |
| Comm  | Yellow  | Device is not connected to the server  | Normal operation or device is not connected to the server if this feature is disabled |
| Power | Green   | Power is connected   | No power  |
| Error | Red     | Error with device  | Normal operation  |
| Event | Reserve | Reserve  | Reserve   |

- **Panic Button**

Panic button is labeled as “Bookmark”.

1) When the bookmark button is pressed, an emergency event recording will be triggered.

If alarm recording cannot be triggered by pressing the button, please check if the Event Rec. is set to “On”, as shown below.

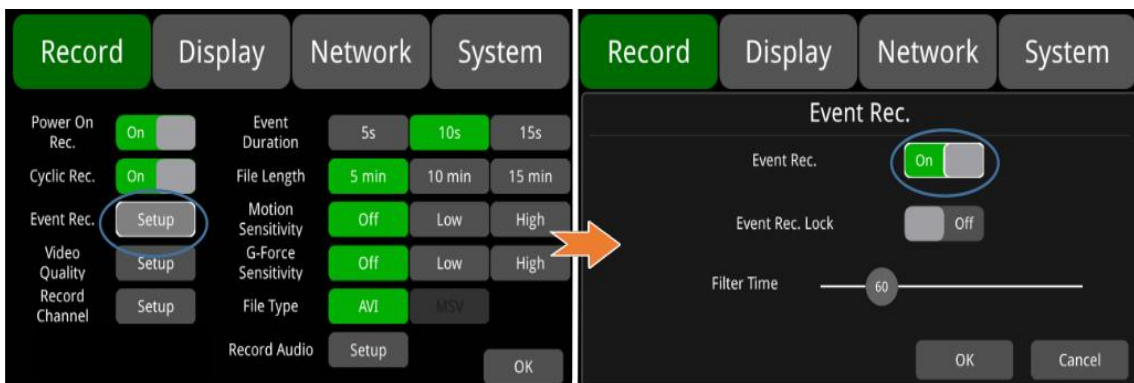

If the alarm recording was triggered, there will be an alarm sign on the screen, as shown below.

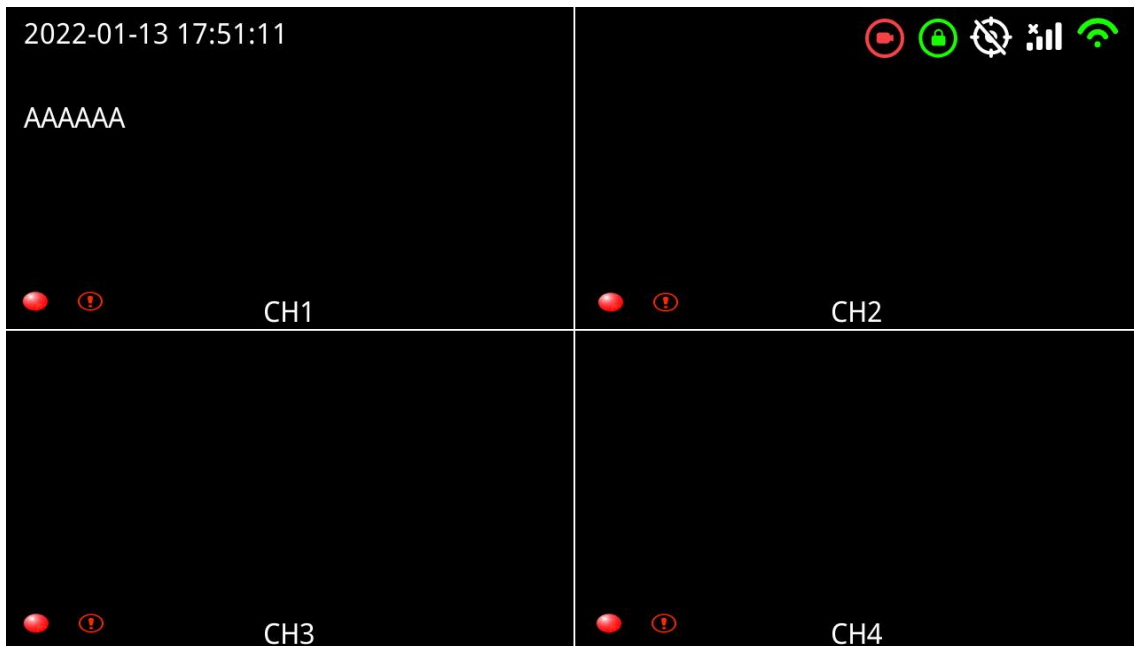

- **IR Receiver**

When the remote control aims to the IR on the panic button, it has the same effect of aiming to that on the device. Sometimes the recorder will be installed in a relatively hidden place in the vehicle, which is not possible for users to directly control the device by remote control. So it will be more convenient for users to operate with the panic button.

- **The Buzzer**

The alarm from the buzzer in the panic button is convenient for checking the status of the device.

In System->Exception, if Power On Buzzer set to "On", alarm buzzer of panic button beeps 15 times continuously when DVR is powered on; if set to "Off", alarm buzzer of panic button will not beep when DVR is powered on.

In System->Exception, if Exception Buzzer is set to "On", the alarm buzzer of panic button beeps with a long frequency when alarms are triggered.

In System->Exception, if Exception Buzzer is set to "Off", the alarm buzzer of panic button will not beeps with a long frequency.

## 6.7 Four-in-one Antenna (GPS, 2G/3G/4G, Wi-Fi)



# 7 Menu

## 7.1 Menu Introduction

Press [MENU] on the remote control or touch the bottom area on a connected LCD screen. The menu will be shown as below. Please log in before entering the menu.

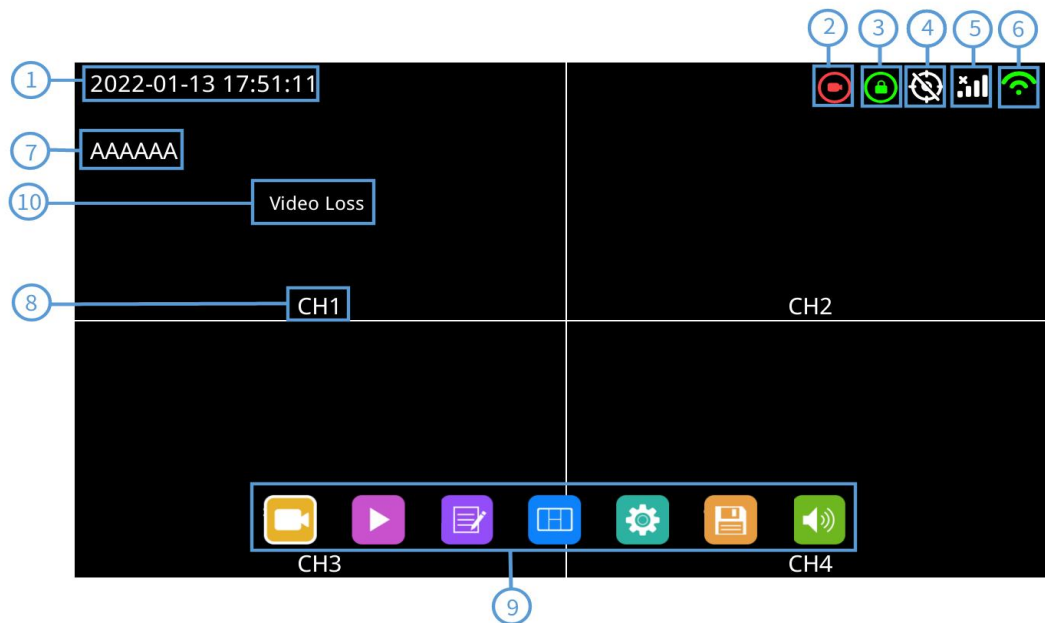



- ① System time display.
- ② Recording .
- ③ Lock.
  - When the front cover is closed, the lock indicator turns green.
  - Mechanical lock is different from menu lock.
- ④ GPS.
  - It flashes in connection process, and when connected, the indicator is always on.
- ⑤ 2G/3G/4G.
- ⑥ Wi-Fi.
- ⑦ License plate number display.
- ⑧ Channel name.
- ⑨ Menu.
  - Click the position of area 9 to display the menu icons.
- ⑩ Video loss.

## 7.2 Menu Lock



- The device/recorder supports two kinds of permissions: admin permission and guest permission.
- Users' account list.

|                       | <b>Admin Permission</b>   | <b>Guest Permission</b>   |
|-----------------------|---|---|
| User Name             | Admin   | Guest   |
| Password Modification | Yes   | No  |
| Initial Password      | 123   | 321   |
| Permission            | Enter all menus   | Enter the menu of Playback, Display mode switching and Volume                         |
|                       |  |  |

- Users' name could not be changed, but users' password is changeable. The guests do not have permission to enter the setup menu, so the password cannot be changed. (See the following instructions to change the password.)

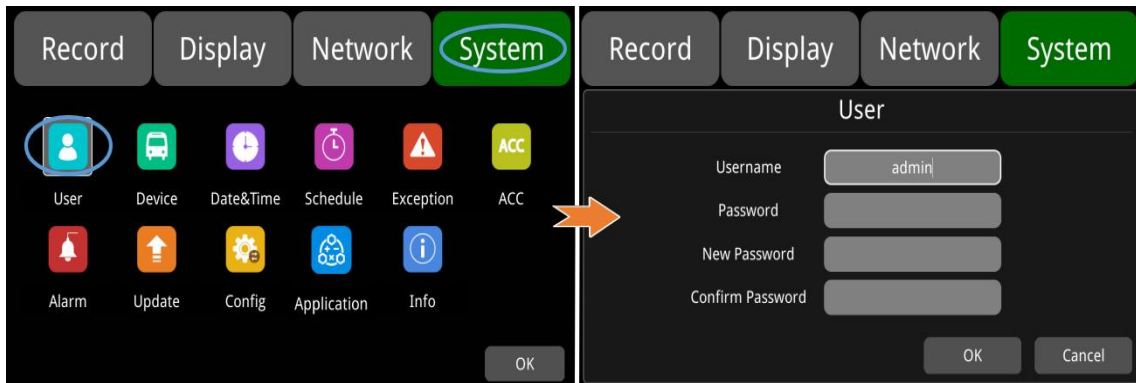

- Only the administrator could change the status of Menu lock. The following picture shows how to change the Menu Lock status from “On” to “Off”.

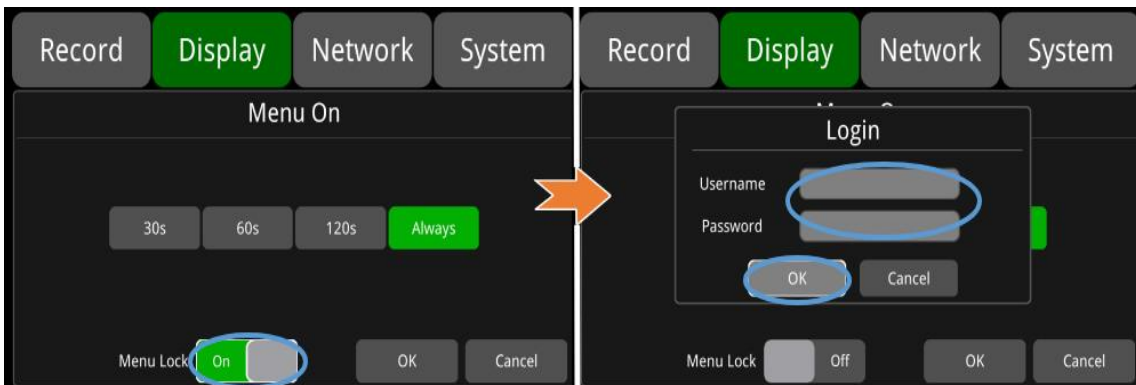

- When the menu lock status is ON, you need to enter the user name “admin” and password to enter the "recording", "play", "log", "settings", "disk", "layer switching" and "volume adjustment" and other menus. If you use the user name “guest” and password, you can only enter the "play", "layer switching" and "volume adjustment" menu. When the menu lock status is "Off", you do not need to enter the user name and password to enter the menu.

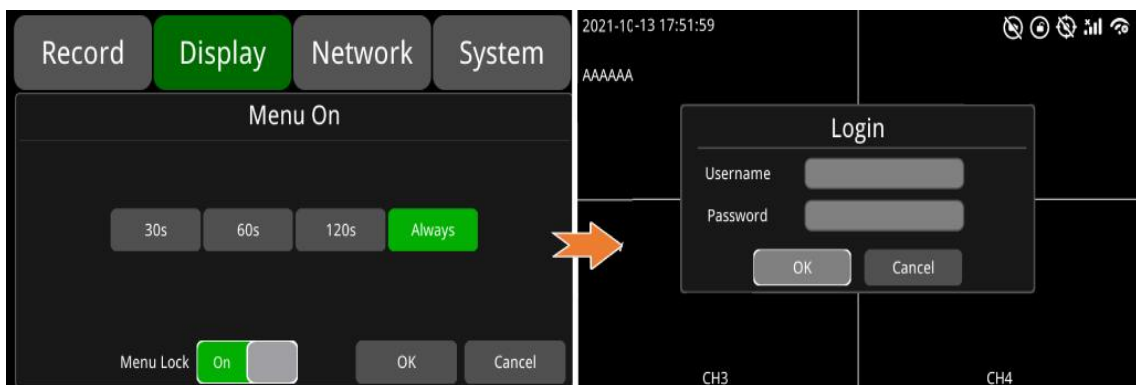



## 7.3 Keyboard Operation Instruction

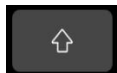
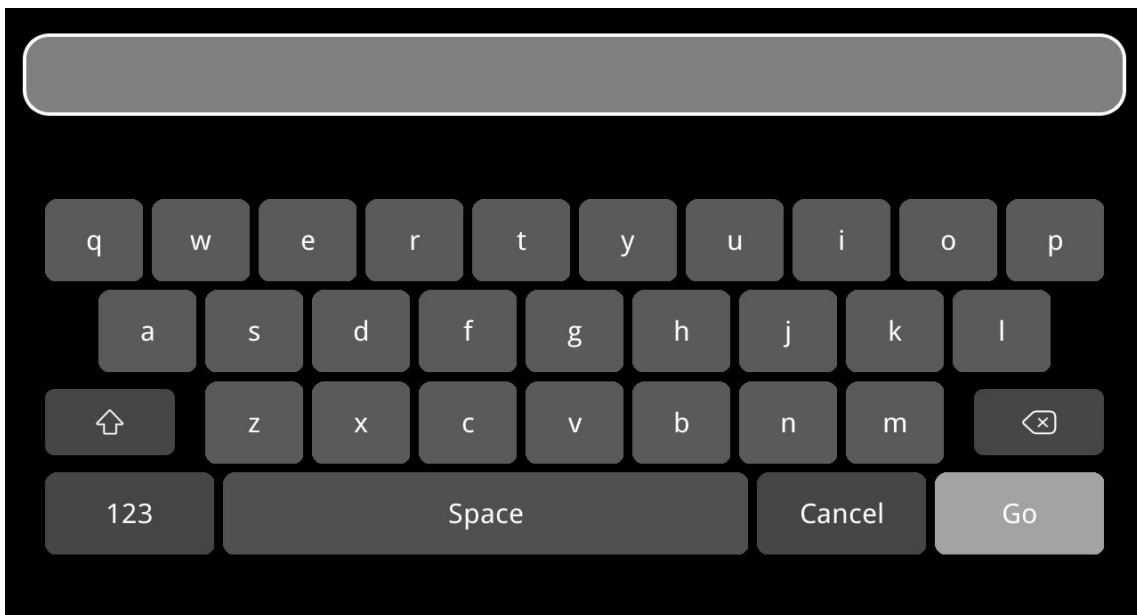

: Switch letter case.

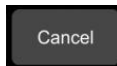

: Exit without saving changes.



: Exit with saving changes.



: Clear input.

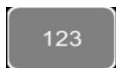

: Switch to the numeric interface.



: Switch to the English alphabet interface.



: Switch to the special character interface.

## Character Switching Introduction

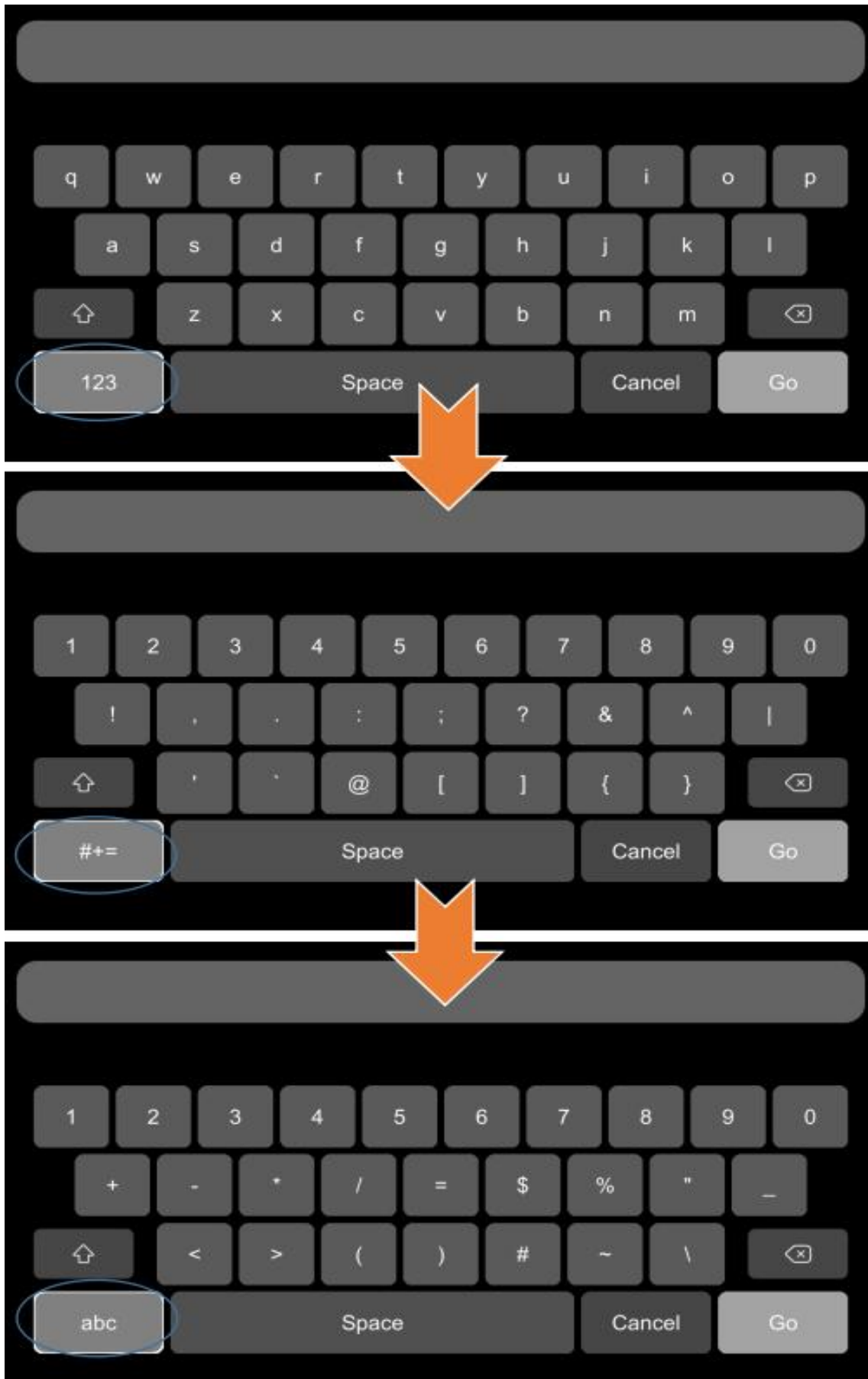

## Letter Case Switching Introduction

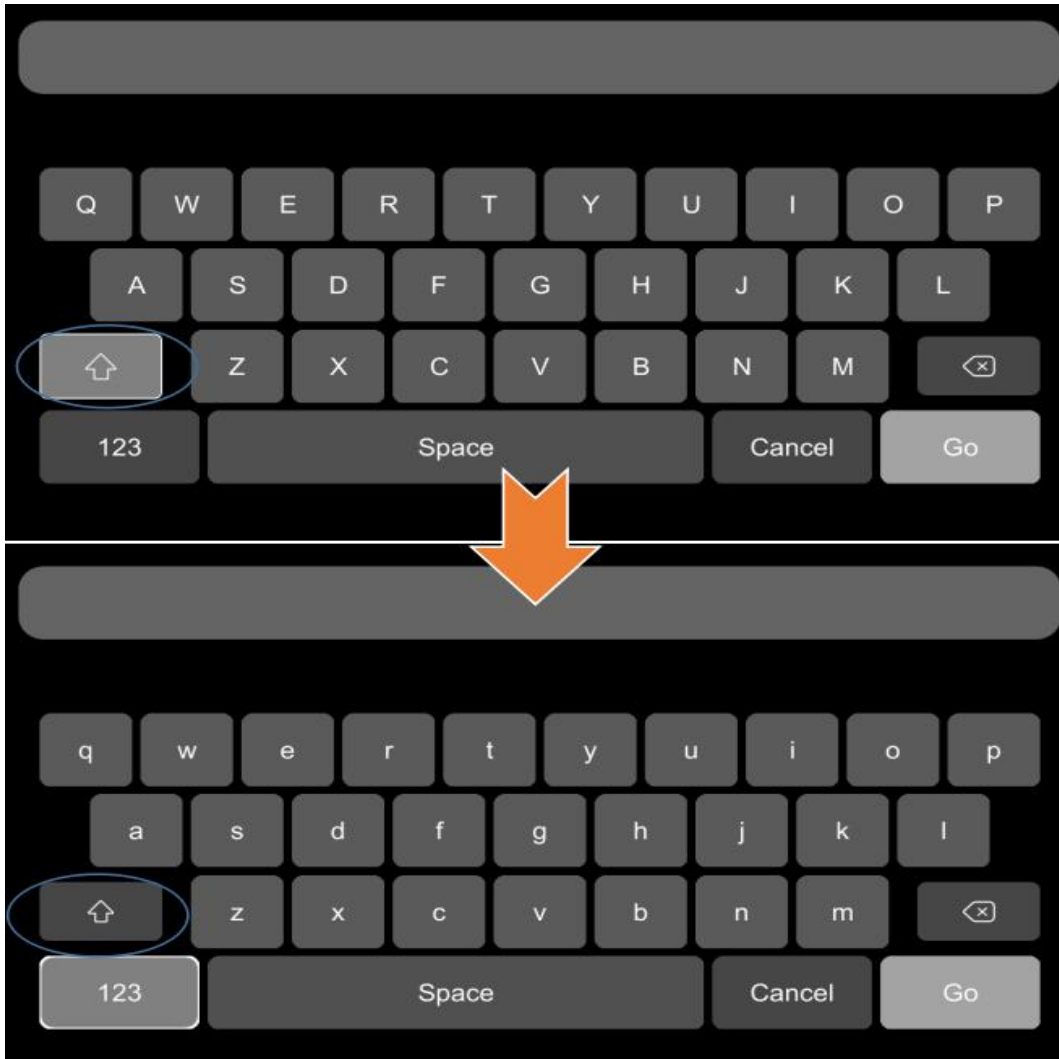

## 7.4 Manual Recording



Recording icon: This version is mandatory to record, so clicking this button can not close or open the record.

## 7.5 Playback



Video Playback button: Touch this icon to enter the calendar menu.

Green marked date means it has recording files saved on that day. Select the date to enter the video file list, then select the file and touch Play icon to play video. You can select single or multiple videos at a time. Multiple videos can be played in sequence and you can shift to the next or the previous one. Specific operation as below.

- Calendar Interface

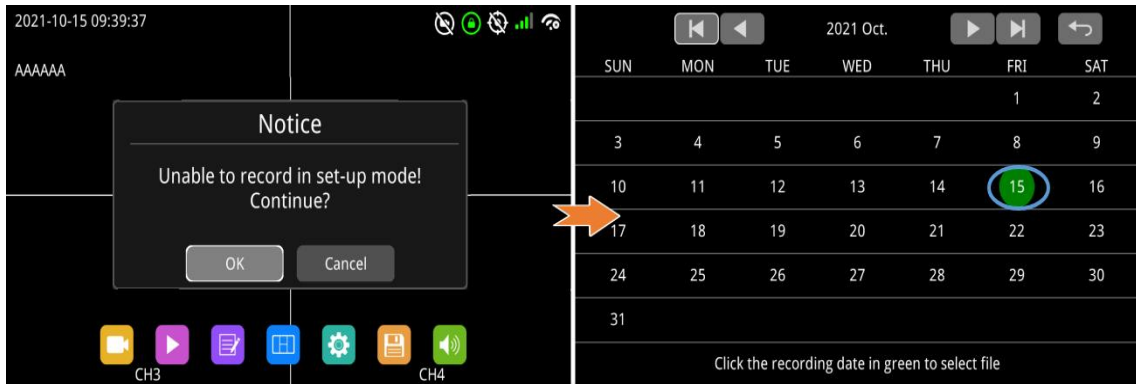

◀ ▶ : Search by month.

⏪ ⏩ : Search by year.

- Record List Interface (1)

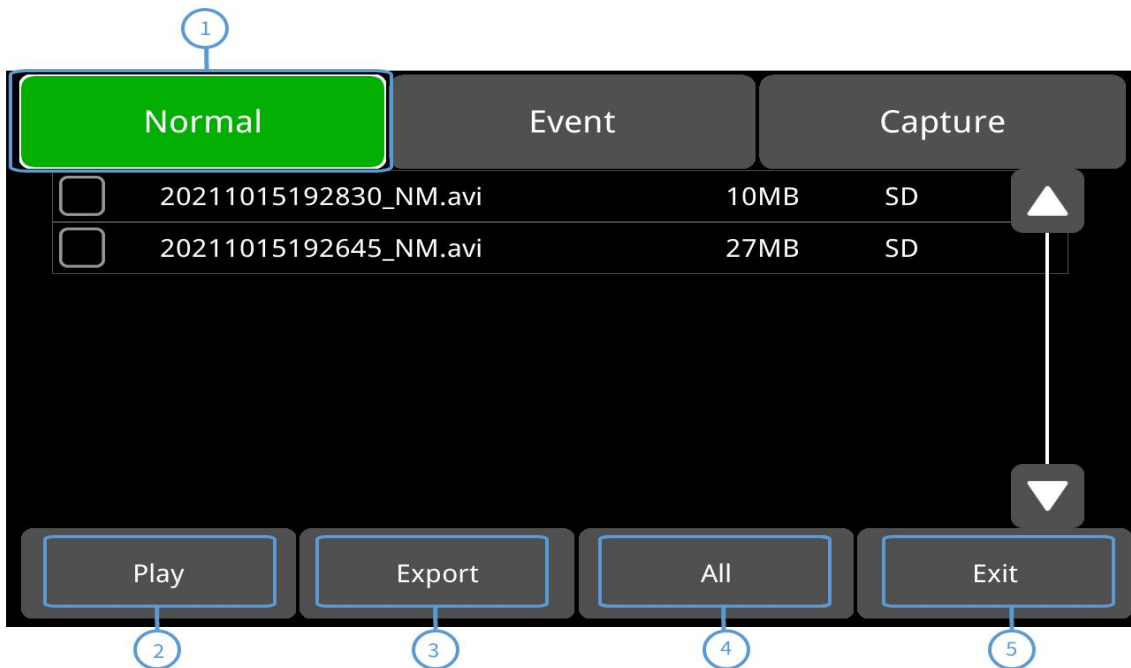

① **Normal**: Recording list, including normal recording, boot recording, timing recording, alarm recording 1~6, motion detection alarm recording, G-Sensor alarm recording, overspeed alarm recording, panic button manual recording alarm , FCW alarm, DMS detection Alarm, LANE departure detection alarm, PDS detection Alarm, BSD detection Alarm.

| Type                           | Recording Time Control Mode | View Position |
|--------------------------------|-----------------------------|---------------|
| Normal recording               | Manual control              | Normal list   |
| Power on recording             | Manual control              | Normal list   |
| Schedule recording             | Pre-setup time              | Normal list   |
| Alarm recording 1~6            | Event recording setup time  | Normal list   |
| Motion detection recording     | Event recording setup time  | Normal list   |
| G-Force recording              | Event recording setup time  | Normal list   |
| Overspeed recording            | Event recording setup time  | Normal list   |
| Panic button recording         | Event recording setup time  | Normal list   |
| FCW alarm recording            | Event recording setup time  | Normal list   |
| DMS alarm recording            | Event recording setup time  | Normal list   |
| LANE departure alarm recording | Event recording setup time  | Normal list   |
| PDS alarm recording            | Event recording setup time  | Normal list   |
| BSD alarm recording            | Event recording setup time  | Normal list   |

- ② **Play:** Play the selected video files.
- ③ **Export:** Export selected video files to external USB devices.
- ④ **All:** Select all seven files on current page.
- ⑤ **Exit:** Exit.

- Record List Interface (2)

There is an abbreviation of record type in the file name, from which you can get the record type of this file. Only .NM video files are generated in the local playback files, and the abbreviations of other video types can be viewed in the client.

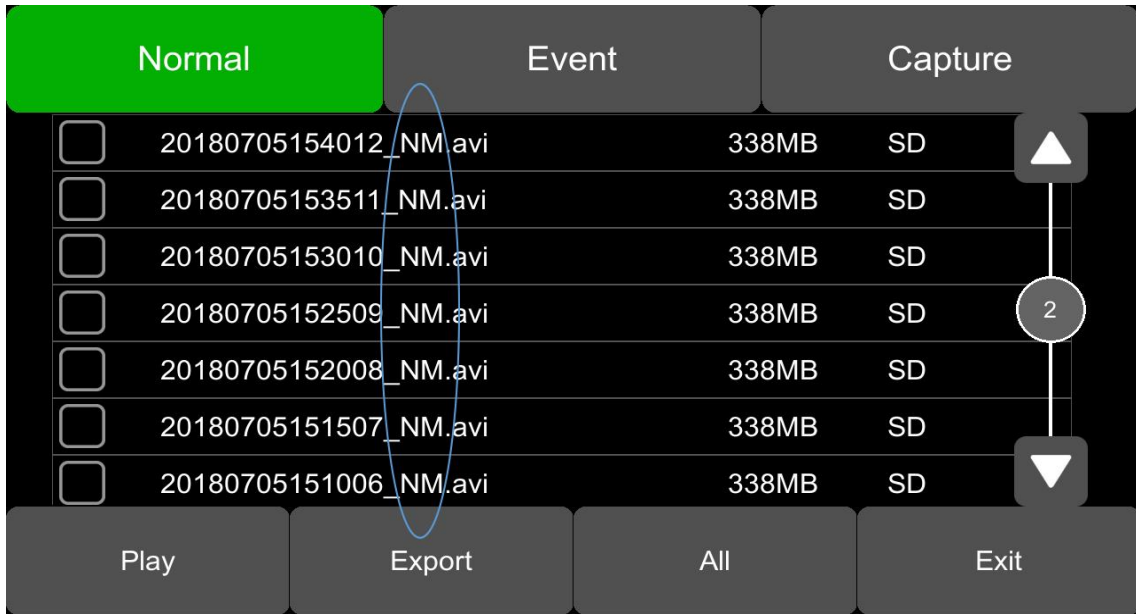

The alarm recording file uploaded to the client is shown in the figure below.

| Device                       | Plate No         | Begin Time          | End Time            | Status        | Percent | Do... | File Size... | File Type             | File Name    | File Positi... |
|------------------------------|------------------|---------------------|---------------------|---------------|---------|-------|--------------|-----------------------|--------------|----------------|
| 555555-455-00013(2107220017) | 555555-455-00013 | 2021-10-25 22:03:46 | 2021-10-25 22:04:05 | Not Downl...  | 0%      | 3     | brake        | 20211025140346_01.avi | Media Ser... |                |
| 555555-455-00013             | 555555-455-00013 | 2021-10-25 22:03:46 | 2021-10-25 22:04:05 | Not Downl...  | 0%      | 3     | brake        | 20211025140346_03.avi | Media Ser... |                |
| 555555-455-00013             | 555555-455-00013 | 2021-10-25 22:03:46 | 2021-10-25 22:04:13 | Not Downl...  | 0%      | 3     | brake        | 20211025140354_01.avi | Media Ser... |                |
| 555555-455-00013             | 555555-455-00013 | 2021-10-25 22:03:54 | 2021-10-25 22:04:13 | Not Downl...  | 0%      | 11    | brake        | 20211025140354_04.avi | Media Ser... |                |
| 555555-455-00013             | 555555-455-00013 | 2021-10-25 22:03:54 | 2021-10-25 22:04:13 | Not Downl...  | 0%      | 3     | brake        | 20211025140354_03.avi | Media Ser... |                |
| 555555-455-00013             | 555555-455-00013 | 2021-10-25 22:03:54 | 2021-10-25 22:04:13 | Not Downl...  | 0%      | 3     | brake        | 20211025140354_01.avi | Media Ser... |                |
| 555555-455-00013             | 555555-455-00013 | 2021-10-25 22:06:16 | 2021-10-25 22:06:35 | Already Do... | 100%    | 3     | smoking      | 20211025140616_02.avi | Media Ser... |                |
| 555555-455-00013             | 555555-455-00013 | 2021-10-25 22:06:16 | 2021-10-25 22:06:35 | Not Downl...  | 0%      | 3     | smoking      | 20211025140616_01.avi | Media Ser... |                |
| 555555-455-00013             | 555555-455-00013 | 2021-10-25 22:06:16 | 2021-10-25 22:06:35 | Not Downl...  | 0%      | 11    | smoking      | 20211025140616_04.avi | Media Ser... |                |
| 555555-455-00013             | 555555-455-00013 | 2021-10-25 22:06:16 | 2021-10-25 22:06:35 | Not Downl...  | 0%      | 3     | smoking      | 20211025140616_03.avi | Media Ser... |                |
| 555555-455-00013             | 555555-455-00013 | 2021-10-25 22:07:59 | 2021-10-25 22:08:12 | Already Do... | 100%    | 7     | gsensor      | 20211025140759_04.avi | Media Ser... |                |
| 555555-455-00013             | 555555-455-00013 | 2021-10-25 22:07:59 | 2021-10-25 22:08:13 | Not Downl...  | 0%      | 2     | gsensor      | 20211025140759_01.avi | Media Ser... |                |
| 555555-455-00013             | 555555-455-00013 | 2021-10-25 22:07:59 | 2021-10-25 22:08:13 | Not Downl...  | 0%      | 2     | gsensor      | 20211025140759_03.avi | Media Ser... |                |
| 555555-455-00013             | 555555-455-00013 | 2021-10-25 22:07:59 | 2021-10-25 22:08:13 | Not Downl...  | 0%      | 2     | gsensor      | 20211025140759_02.avi | Media Ser... |                |
| 555555-455-00013             | 555555-455-00013 | 2021-10-25 22:13:59 | 2021-10-25 22:14:14 | Not Downl...  | 0%      | 3     | motion       | 20211025141359_01.avi | Media Ser... |                |
| 555555-455-00013             | 555555-455-00013 | 2021-10-25 22:13:59 | 2021-10-25 22:14:14 | Not Downl...  | 0%      | 9     | motion       | 20211025141359_04.avi | Media Ser... |                |
| 555555-455-00013             | 555555-455-00013 | 2021-10-25 22:13:59 | 2021-10-25 22:14:14 | Not Downl...  | 0%      | 3     | motion       | 20211025141359_02.avi | Media Ser... |                |
| 555555-455-00013             | 555555-455-00013 | 2021-10-25 22:13:59 | 2021-10-25 22:14:14 | Not Downl...  | 0%      | 3     | motion       | 20211025141359_03.avi | Media Ser... |                |
| 555555-455-00013             | 555555-455-00013 | 2021-10-25 22:16:31 | 2021-10-25 22:16:34 | Not Downl...  | 0%      | 1     | alarm2       | 20211025141631_01.avi | Media Ser... |                |
| 555555-455-00013             | 555555-455-00013 | 2021-10-25 22:16:31 | 2021-10-25 22:16:34 | Already Do... | 100%    | 1     | alarm2       | 20211025141631_03.avi | Media Ser... |                |
| 555555-455-00013             | 555555-455-00013 | 2021-10-25 22:16:31 | 2021-10-25 22:16:34 | Not Downl...  | 0%      | 2     | alarm2       | 20211025141631_04.avi | Media Ser... |                |
| 555555-455-00013             | 555555-455-00013 | 2021-10-25 22:16:31 | 2021-10-25 22:16:34 | Not Downl...  | 0%      | 1     | alarm2       | 20211025141631_02.avi | Media Ser... |                |
| 555555-455-00013             | 555555-455-00013 | 2021-10-25 22:16:39 | 2021-10-25 22:16:47 | Not Downl...  | 0%      | 2     | alarm2       | 20211025141639_03.avi | Media Ser... |                |
| 555555-455-00013             | 555555-455-00013 | 2021-10-25 22:16:39 | 2021-10-25 22:16:47 | Not Downl...  | 0%      | 5     | alarm2       | 20211025141639_04.avi | Media Ser... |                |
| 555555-455-00013             | 555555-455-00013 | 2021-10-25 22:16:39 | 2021-10-25 22:16:47 | Not Downl...  | 0%      | 2     | alarm2       | 20211025141639_01.avi | Media Ser... |                |
| 555555-455-00013             | 555555-455-00013 | 2021-10-25 22:16:39 | 2021-10-25 22:16:47 | Not Downl...  | 0%      | 2     | alarm2       | 20211025141639_02.avi | Media Ser... |                |
| 555555-455-00013             | 555555-455-00013 | 2021-10-25 22:20:01 | 2021-10-25 22:20:14 | Already Do... | 100%    | 2     | distractio   | 20211025142001_03.avi | Media Ser... |                |
| 555555-455-00013             | 555555-455-00013 | 2021-10-25 22:20:01 | 2021-10-25 22:20:14 | Not Downl...  | 0%      | 7     | distractio   | 20211025142001_04.avi | Media Ser... |                |
| 555555-455-00013             | 555555-455-00013 | 2021-10-25 22:20:01 | 2021-10-25 22:20:14 | Not Downl...  | 0%      | 2     | distractio   | 20211025142001_01.avi | Media Ser... |                |
| 555555-455-00013             | 555555-455-00013 | 2021-10-25 22:20:01 | 2021-10-25 22:20:14 | Not Downl...  | 0%      | 2     | distractio   | 20211025142001_02.avi | Media Ser... |                |

The alarm recording files downloaded from the client are shown in the figure below.

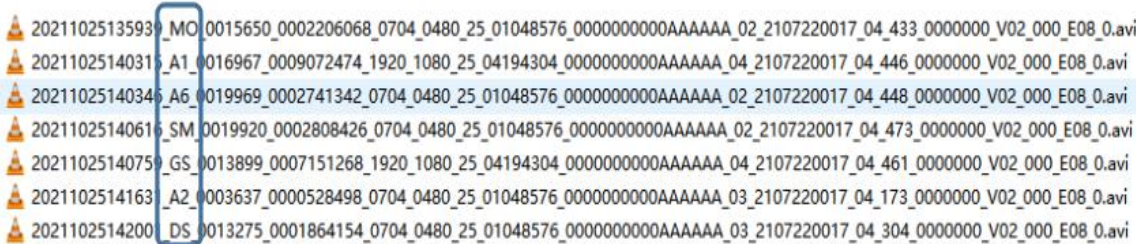





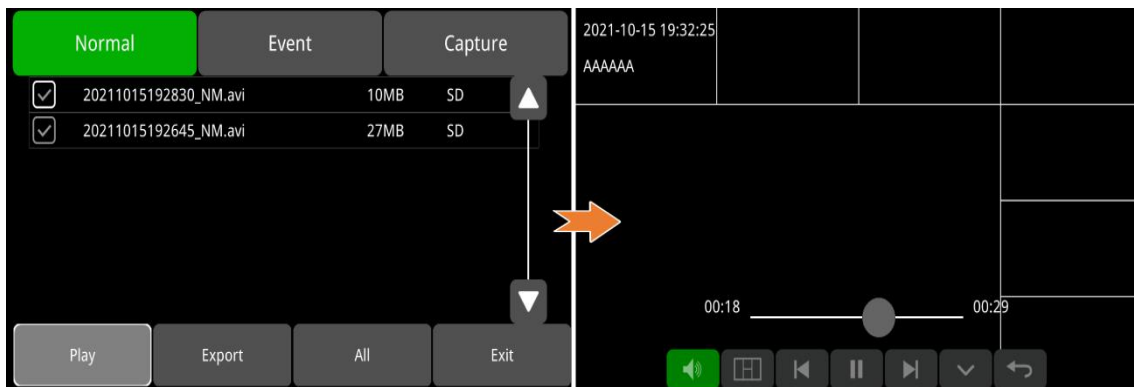

The abbreviations of recording types are as follows.

|    |                                |    |   |
|----|--------------------------------|----|---|
| NM | Normal recording               | TI | Scheduled recording                             |
| MO | Motion detection recording     | SP | Speed recording (the speed source is GPS)       |
| TP | Temperature recording          | BT | Panic button recording                          |
| A1 | Alarm 1 recording              | A2 | Alarm 2 recording                               |
| A3 | Alarm 3 recording              | A4 | Alarm 4 recording                               |
| A5 | Reverse recording              | A6 | Brake recording                                 |
| PB | Pedestrian detection recording | CR | Collision alarm recording                       |
| SK | Lane deviation alarm recording | OS | Over speed recording (the speed source is ADAS) |
| GS | G-Sensor recording (easy mode) | ND | No driver alarm recording                       |
| FT | Fatigue alarm recording        | DS | Distraction alarm recording                     |
| CA | Phone using alarm recording    | SM | Smoking alarm recording                         |

- Play Interface

After selecting files, press "Play" button to play the files.



-  : Volume control.
-  : Select the playback view modes.
-  : Play the previous/next video file.
-  : Pause/Resume playing.
-  : Hide the menu. Press [Area 1] to display.
-  : Exit Play.

## 7.6 Log



System Log query and export.

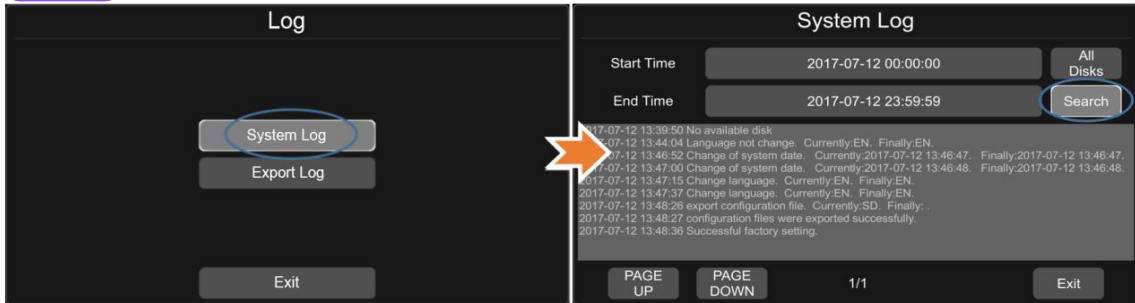

## 7.7 Display Mode Switching



Display mode switch: Press the icon to display multiple types of mode. The default mode is automatic view.



- ① Display mode selection.
- ② Touch the icon to set up the default.
- ③ Exit.

## 7.8 System



System settings: Touch the icon to enter the setup menu. A window notice of "Unable to record in set-up mode! Continue?" will be popped up, and touch "OK" to enter.



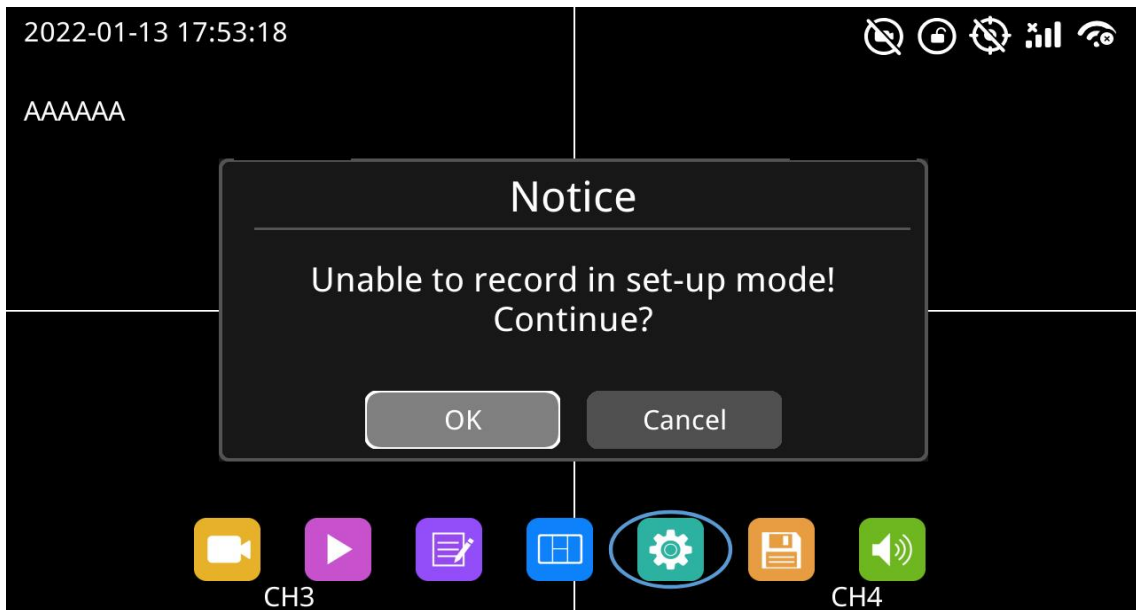

## 7.9 Disk



Disk management: Touch the icon, then you can view the status of SSD, SD card and USB storage as below.

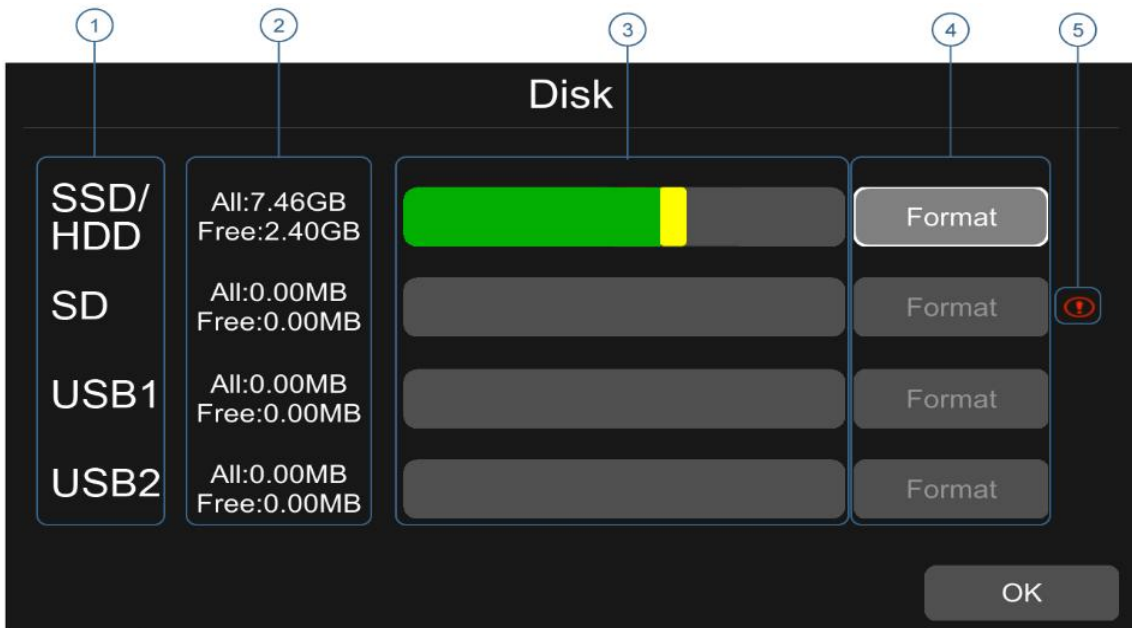

- ① Disk types.
- ② Disk capacity.
  - All: The total capacity of individual disk.
  - Free: The remaining capacity of disk.

If All shows 0.00MB, it means that DVR does not have access to this type of disk.

- ③ Disk capacity bar

- The green bar shows the size of all video files in the "Normal" list.
  - The yellow bar shows the size of all other files except the above files.
- ④ Touch to format the disk.

A window notice of "Disk data will be deleted! Continue?" will be popped up. Press "OK" to start formatting the disk.

The following figure is an example of formatting USB2.

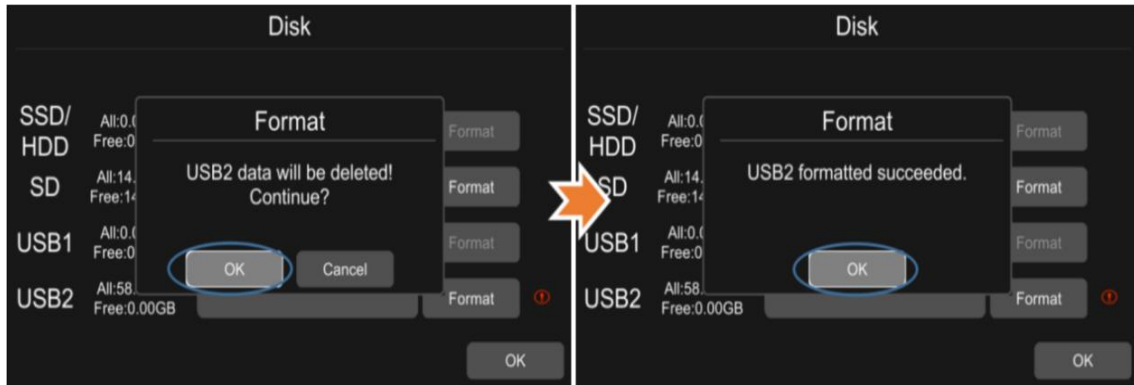

If the disk could not be formatted, please check if there is a disk in the slot.

- ⑤ It shows that the disk needs to be formatted before application.

Usually, all new disks must be formatted before application.

## 7.10 Volume



Volume: 0~10. The default value is 7.

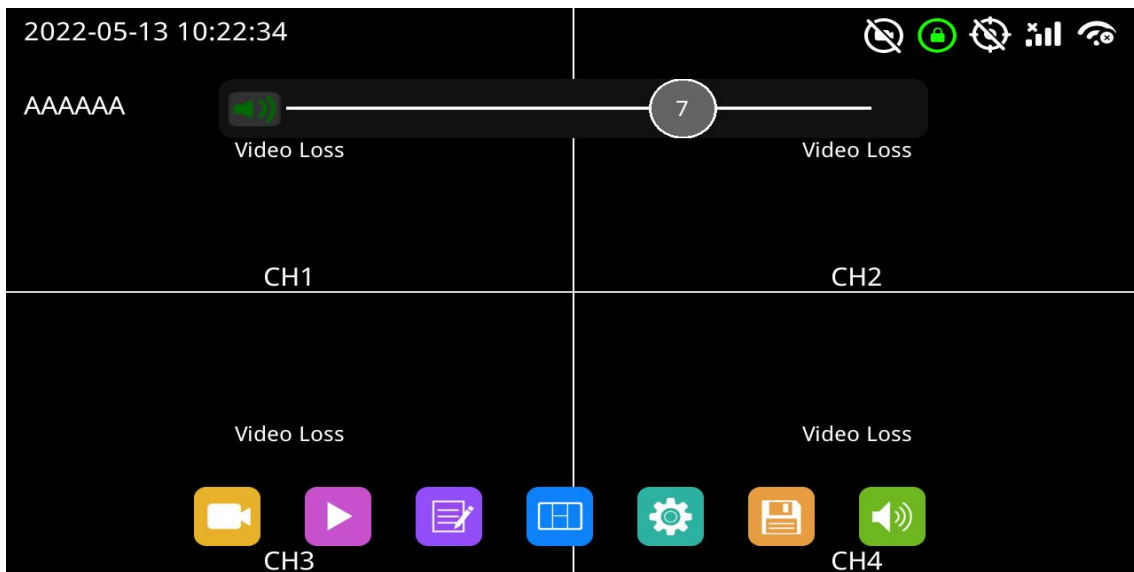

| Function | Min. | Max. | Default |
|----------|------|------|---------|
| Volume   | 0    | 10   | 7       |

## 8 Record Setup

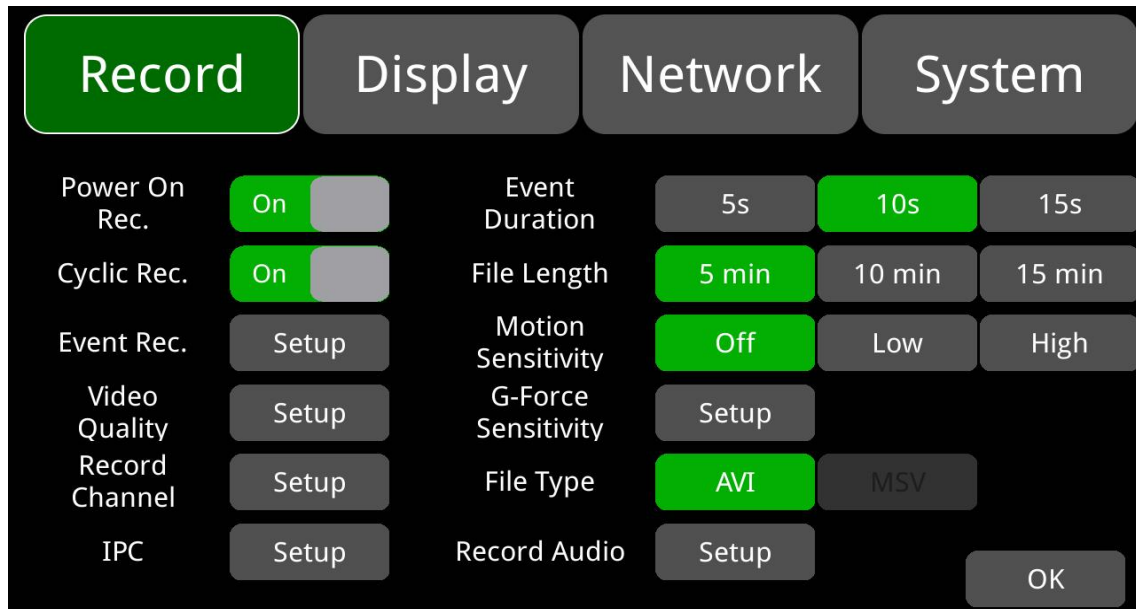

### 8.1 Power On Rec.



When “Power On Rec.” is set to “On”, the device will start recording once it is powered on. Default setting is ON.

### 8.2 Cyclic Rec.



When “Cyclic Rec.” is set to “On”, new recording files will overwrite the previous ones if the disk is full. Otherwise, it will stop recording when it is set to “Off” and the disk is full.

This function is ON by default, and will overwrite all video files, including event video files.

### 8.3 Event Rec.



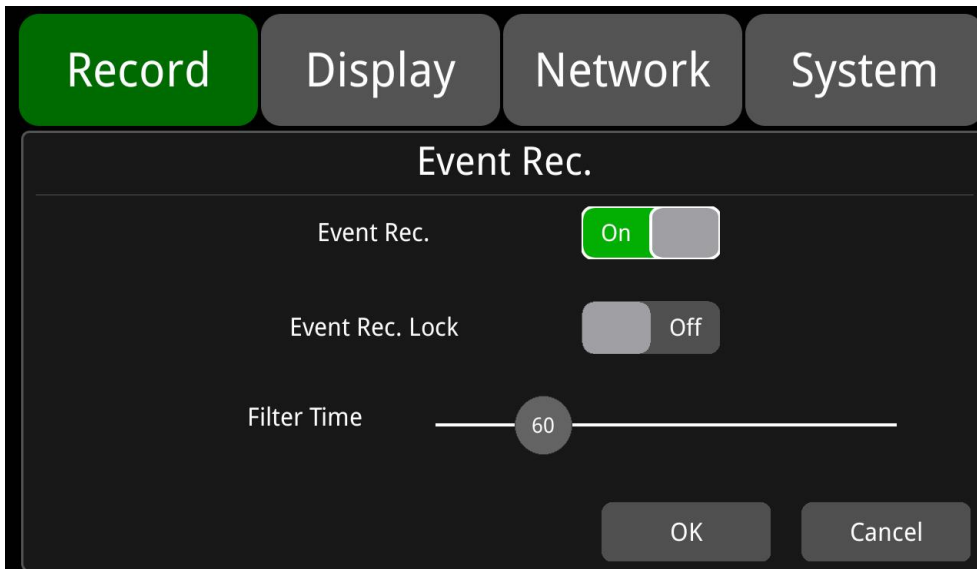

**Event Rec.:** Event recording refers to the alarm recording triggered by events including motion detection, G-Sensor, alarm 1 ~ 6, panic button and over speed, FCW alarm, DMS detection alarm, LANE departure alarm. If the Event Rec. is set to “On” and corresponding alarm parameters are set, event recording will be activated when the events above are triggered. If the Event Rec. is set to “Off”, event recording will not be activated even if an alarm is triggered. This function is ON by default.

**Event Rec. Lock:** reserved

**Filter Time:** Time filtering. As shown in the figure, if the same alarm is triggered continuously, every 60s the DVR generates an alarm message and checks whether a new alarm recording is generated. When the DVR is connected to the Internet, the alarm information will be sent to the server. The minimum value of Filter Time is 1s and the maximum can be set to 300s, with the default value of 60s.

## 8.4 Video Quality

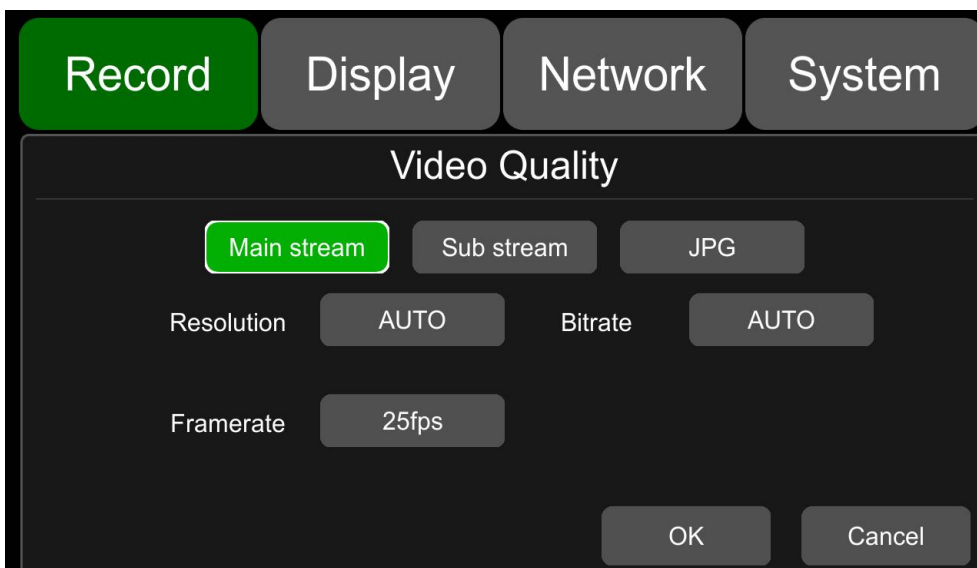

The main stream is used for video storage. The sub stream is used for network transmission.

The default configuration of main stream, sub stream and JPG are as follows.

|            | Main Stream | Sub Stream | JPG  |
|------------|-------------|------------|------|
| Resolution | AUTO        | CIF        | None |
| Bitrate    | AUTO        | 64Kbps     | None |
| Framerate  | 25fps       | 25fps      | Low  |

### ① Resolution

Here are 5 optional resolutions in the main stream menu, 1080P, 720P, D1 (PAL), D1 (NTSC), and AUTO.

The sub-stream menu defaults to CIF and it is not selectable. The higher the resolution, the better the quality of the video file and the larger the size of it. Therefore, the file size should be considered during configuration.

In the options of Resolution, AUTO is defined as follows.

|      | Main stream  |
|------|--|
| AUTO | DVR will recognize the camera format, and will record videos of that format. |

### ② Bitrate

There are 8 levels of bitrate to choose from in the main stream menu, 4Mbps, 2Mbps, 1Mbps, 512Kbps, 256Kbps, 128Kbps, 64Kbps, and AUTO; in the sub stream menu, there are 6 levels of bitrate to choose from, 1Mbps, 512Kbps, 256Kbps, 128Kbps, 64Kbps and AUTO. The higher the bit rate, the clearer the image and the larger the video file. Therefore, all factors should be considered in the options of Bitrate.

In the options of Bitrate, AUTO is defined as follows.

| Bitrate |  |  |
|---------|--|--|
|         | Main stream  | Sub stream   |
| AUTO    | If a 1080P camera is connected, the bitrate will be 4Mbps. For a 720P camera, it'll be 2Mbps. And for a D1 camera, it'll be 1Mbps. | Whatever cameras are connected, the bitrate will always be 64Kbps. |

③ **Framerate**

There are 8 kinds of optional frame rates in Main stream and Sub stream menu: 30fps(NTSC), 28fps (NTSC),25fps, 20fps, 15fps, 14fps, 10fps and 5fps. The higher the frame rate, the smoother the recording, and the larger the video file. (Note: mixed connection of cameras with different framerates is not allowed.)

| SSD / SD Capacity | Video Quality     | File Length |
|-------------------|-------------------|-------------|
| 2TB               | 4 x 1080P / 4Mbps | ≈298h       |
|                   | 4 x 720P / 2Mbps  | ≈596h       |
|                   | 4 x D1 / 1Mbps    | ≈1193h      |
|                   | 1 x 1080P / 4Mbps | ≈1193h      |
|                   | 1 x 720P / 2Mbps  | ≈2386h      |
|                   | 1 x D1 / 1Mbps    | ≈4772h      |
| 512GB             | 4 x 1080P / 4Mbps | ≈75h        |
|                   | 4 x 720P / 2Mbps  | ≈149h       |
|                   | 4 x D1 / 1Mbps    | ≈298h       |
|                   | 1 x 1080P / 4Mbps | ≈298h       |
|                   | 1 x 720P / 2Mbps  | ≈596h       |
|                   | 1 x D1 / 1Mbps    | ≈1193h      |

④ **JPG**

JPG Framerate are available in Excellent, High, Mid, and Low. The meanings of these four values are as follows.

|           |  |
|-----------|--|
| Excellent | The rate of uploading pictures to the client is unlimited (the fastest), and the rendering effect is the smoothest |
| High      | The rate of uploading pictures to the client is 1 second per picture   |
| Mid       | The rate of uploading pictures to the client is 3 second per picture   |
| Low       | The rate of uploading pictures to the client is 5 second per picture   |

## 8.5 Record Channel

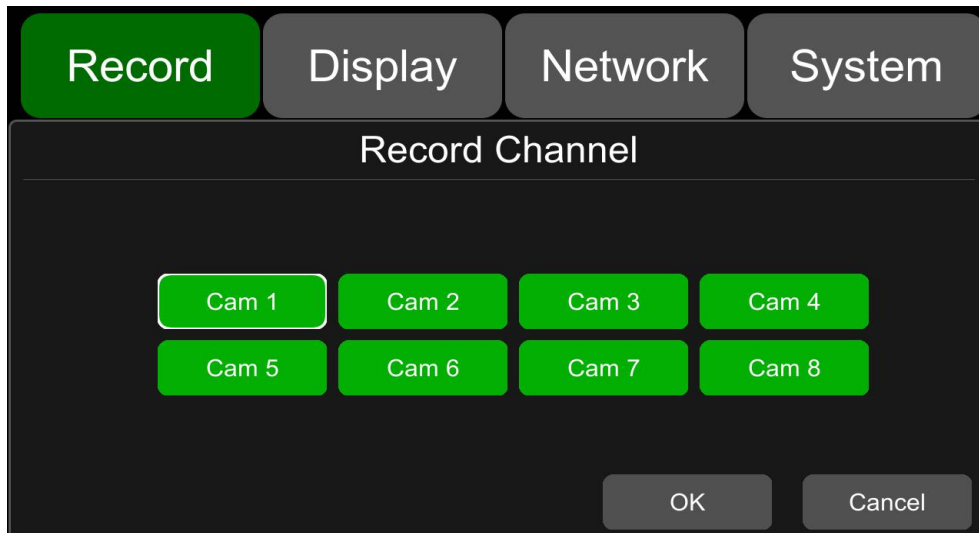

The default configuration is shown above.

Select the record channel. When recording is turned on (including all types of recording), all channels will be recorded; this version forces recording. Even if the record channel is turned off, correspondingly it will still be recorded.

## 8.6 IPC Setup



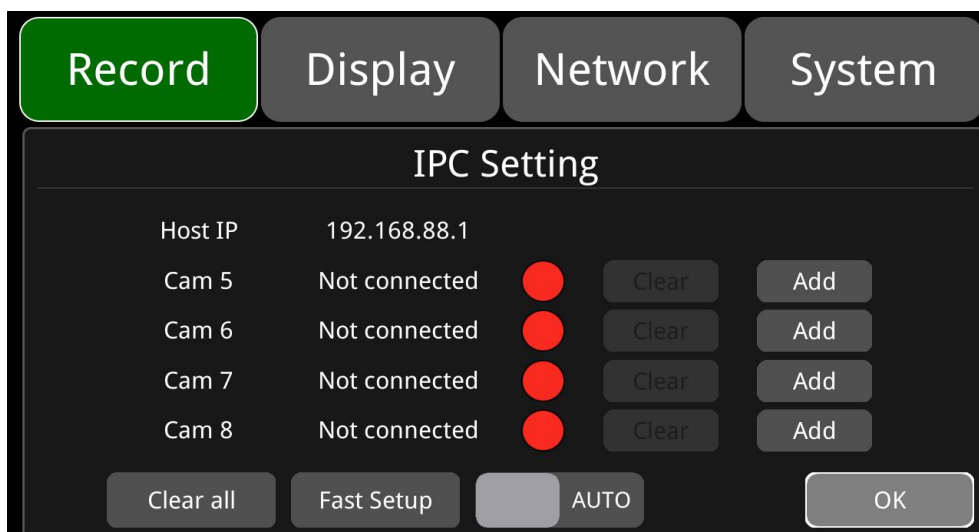

The default configuration is shown in the picture.

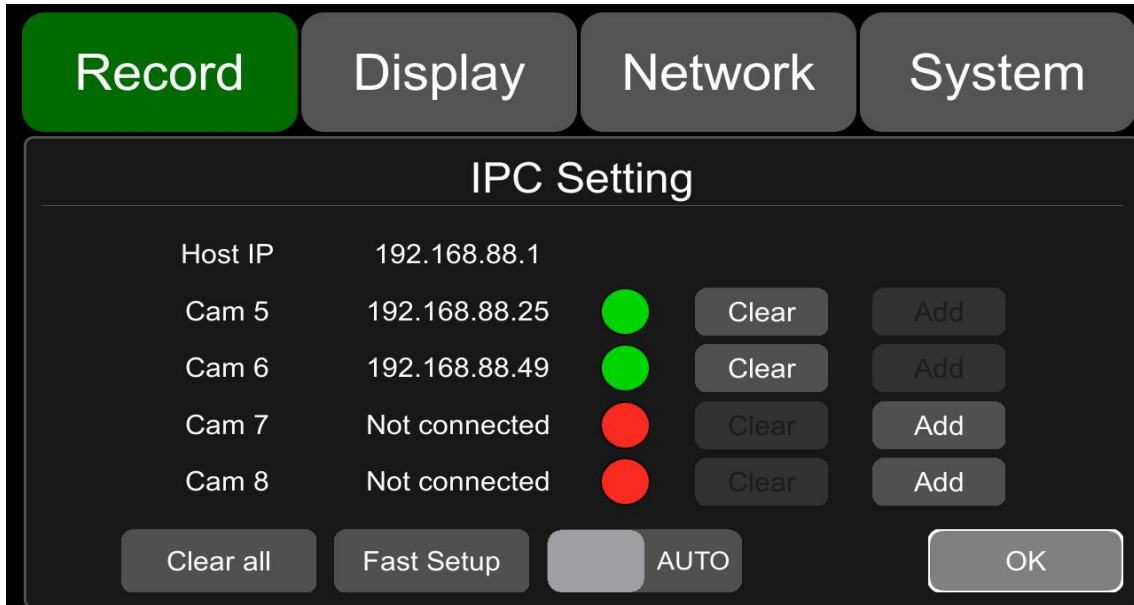

The default Host IP of the DVR is 192.168.88.1. The IPC can be applied when it is connected to the same network as the DVR. One DVR can connect up to 4 IPC channels.

**AUTO:** AUTO is OFF by default. When it is turned on, the detected IPC is automatically connected. When AUTO is set to "On", Clear, Add, Clear All, and Fast Setup settings all cannot be operated.



 : Indicate that the IPC has been connected successfully.

 : Indicate that no IPC is connected.

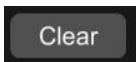
 Clear: Press the button, then the DVR will disconnect the IPC that has been successfully connected to the corresponding channel.

 Add: Button for entering the IPC-adding interface.

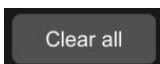
 Clear All: Press the button, then the DVR will disconnect all IPC channels that have been connected successfully.

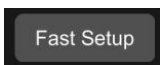

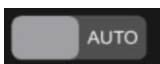

 Fast Setup: Press the button, then all IPCs are connected to the device quickly.

 AUTO: Automatically connect to the detected IPC. When AUTO is set to "On", Clear, Add, Clear All, and Fast Setup settings cannot be operated. AUTO is off by default.

 OK: Save the interface and exit.

 Add: IPC-adding interface.



| Record                              |                      | Display              | Network              | System  |
|-------------------------------------|----------------------|----------------------|----------------------|---|
| No.                                 | IP                   | User Name            | Password             | Status  |
| <input type="checkbox"/> 1.         | 192.168.70.127       | <input type="text"/> | <input type="text"/> |  |
| <input type="checkbox"/> 2.         | 192.168.88.233       | <input type="text"/> | <input type="text"/> |  |
| <input type="checkbox"/> 3.         | 192.168.70.175       | <input type="text"/> | <input type="text"/> |  |
| <input type="checkbox"/> 4.         | 192.168.88.192       | <input type="text"/> | <input type="text"/> |  |
| <input type="checkbox"/> Manual add | <input type="text"/> | <input type="text"/> | <input type="text"/> |   |

**IP:** Indicate the IP of the relevant IPC searched by the DVR.

**User Name:** IPC user name.

**Password:** IPC password.

**Status:** The connection status of the searched IPC; the relevant status is explained as follows:



: Indicate that the IP network segment of the IPC is inconsistent with that of the DVR, which means the network segment is incorrect.



: Indicate that the IPC is normal and can be connected to the DVR.



: Indicate that the IPC has been connected successfully.



: Indicate that the IP format of the IPC is malformed.

**Manual add:** If the IP connected to the IPC is not found, you can add the IPC by manually entering the IP, User Name and Password of the IPC. If the IPC does not have a user name and password, you only need to enter the IP of the IPC.

**Add:** IPC- adding button, after pressing the Add button, the IP of the selected IPC will show that the connection is successful.

**Filter:** If the filter is turned on, the screen will not display the IPC that the DVR has successfully connected to in this interface; when the filter is off, the screen displays all searched IPCs in this interface.

**Refresh:** If the IP connected to the IPC is not found in the interface shortly after booting, you can click this button to refresh the interface.

**OK:** Save the configuration and exit the interface.

**Cancel:** Do not save the configuration and exit the interface.

After the IPC connection is successful, you can view the IPC channel recording via the following interface.

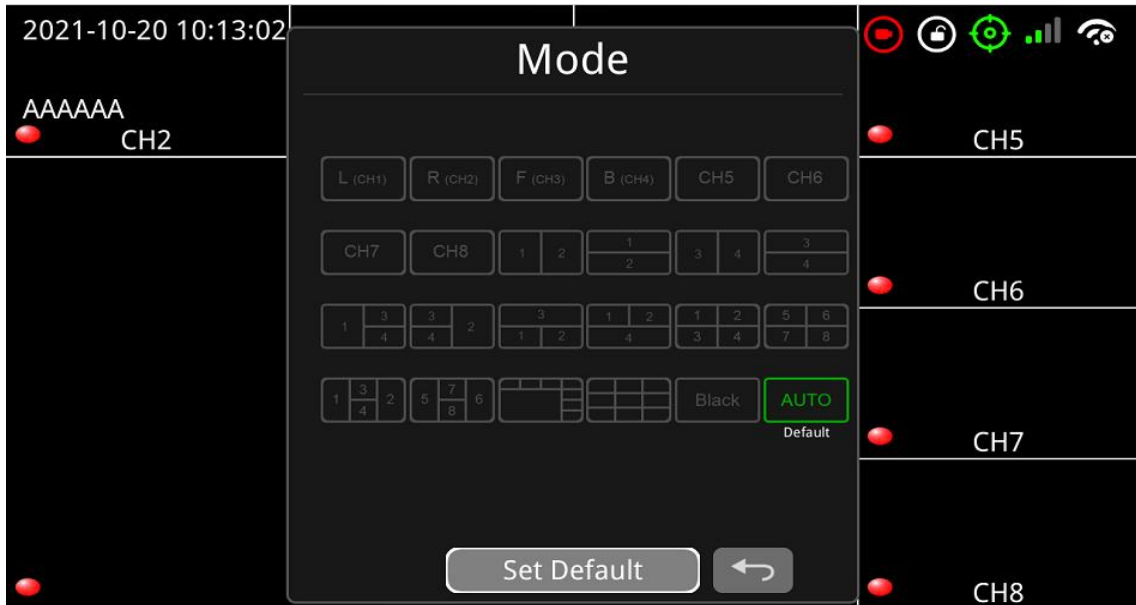

When IPC AUTO is the Default setting, the restarted DVR automatically switches to an eight-split display on the main and sub-screen after 1min of being connected to the IPC channel. If the IPC channel is not connected, the DVR automatically switches to a four-division display of CH1~CH4 after 1min; if you select other split modes other than AUTO as the Default setting, the DVR will display the chosen split mode upon restarting.

## 8.7 Event Duration



When the “Event Rec.” is set to “On”, the event duration of event recordings can be set to 5~180s. The default is 10s.

## 8.8 File Length



The default video file length for AVI format is 5 min.

The length of the video file in AVI format can be set to 5 min, 10 min, and 15 min.

| File Format | File Length      |
|-------------|------------------|
| AVI         | 5min,10min,15min |

## 8.9 Motion Sensitivity



The default configuration is shown above.

Motion detection recording and sensitivity level setting: Motion detection recording will be triggered when an object moves and its movement exceeds the preset motion detection sensitivity level. For such kind of event recording, the pre-recording time is fixed at 10s and the post-recording time is configured by the Event Duration above.

Total video file length equals to the pre-recorded file length (fixed 10s) plus the file length configured in Event Duration.

If motion detection is set to "Off", event recording will not be triggered. Motion detection sensitivity can be set to two levels, "Low" or "High". Motion detection recording will be on when Low / High is selected. And it will be off when "Off" is selected.

## 8.10 G-Sensor Sensitivity

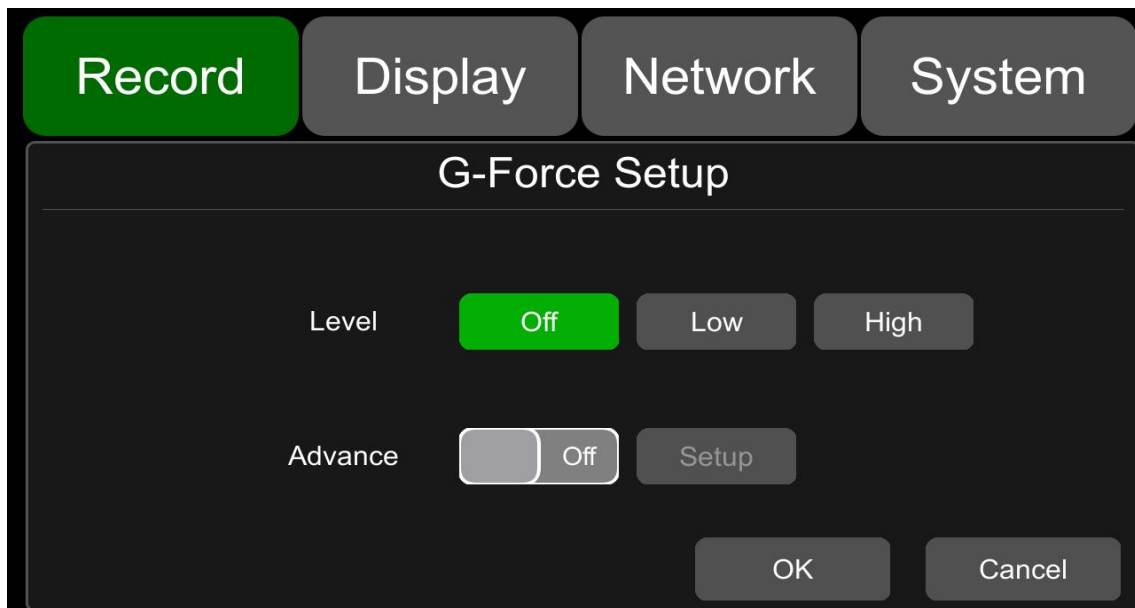

The default configuration is shown above.

There are two optional setting modes for G-force, simple mode and advanced mode. It only requires setting the trigger level of G-force if the simple mode is selected. Detailed instruction is as follow.

When the acceleration or gyroscope of the device reaches the preset sensitivity level, G-force recording will be triggered. For such kind of event recording, the pre-recording time is set to 10s by default and the post-recording time is configured by the Event Duration above.

Total video file length equals to pre-recording file length (default is 10s) plus the file length configured in Event Duration.

If G-force trigger is turned off, event recording will not be triggered. G-force sensitivity can be set to two levels, Low / High. G-force triggered recording will be on when Low / High is selected. And it will be off when "Off" is selected.

If the advanced mode is set to "On", the simple mode will be disabled automatically. Detailed instruction is as follow.

- Principle of G-force Alarm Triggering Detection

The device will utilize a nine-axis G-force sensor, which can transmit data that includes acceleration and angular velocity, to measure and detect the acceleration and angular velocity of the vehicle when the it moves or makes a turn. When the acceleration and angular velocity exceeds a certain threshold within a certain period of time, the corresponding alarm will be triggered and start recording. Then the detected data will be uploaded to the cloud (Detection principle is shown in Pic 1.1). For example, based on the detected data, if the acceleration of the vehicle while moving or making a turn exceeds the certain threshold "a" during the period "T" (default is 100ms), it will be recognized as excessive speed in acceleration or turning, which is prone to cause traffic accidents.

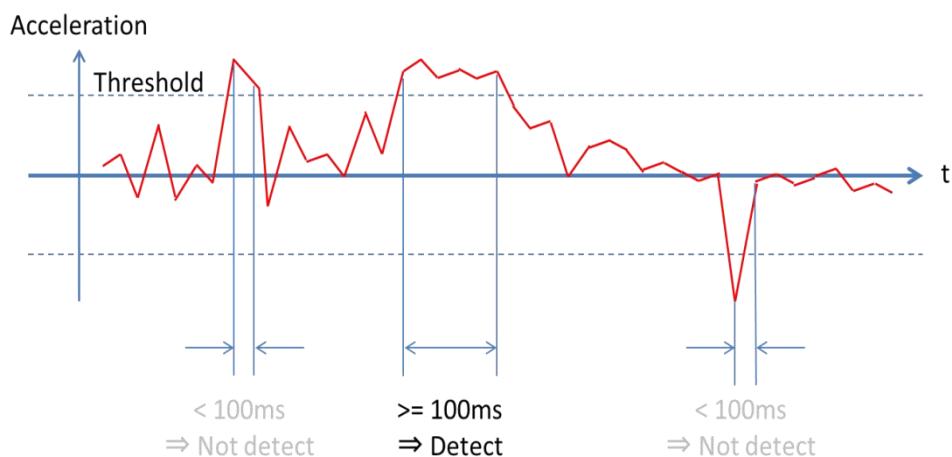

- Introduction to G-force Alarm Triggering Setting Interface

Enter the setting interface of the advanced mode of G-force under "Menu" -> "Record" -> "G-force Sensitivity" -> "Setup" -> "Advance" -> "ON".

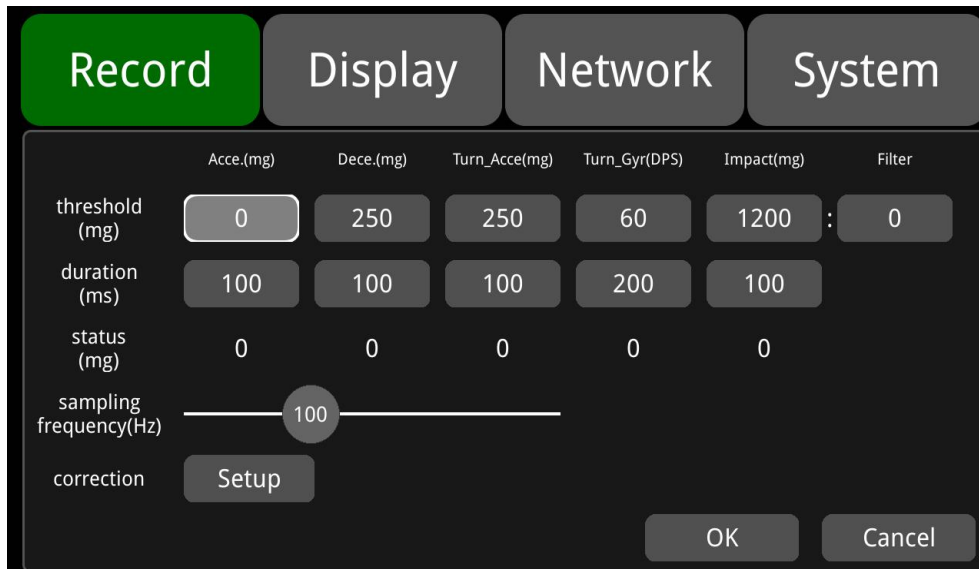

The meanings of “Acce”, “Dece”, “Turn\_Acce”, “Turn\_Gyr”, “Impact” and Filter” are as follow.

| Items     | Meanings  |
|-----------|---|
| Acce.     | The value of acceleration when the vehicle is in motion (for detecting sudden acceleration)   |
|           | When the vehicle is accelerating, the value will be a positive number. And when it is decelerating, the value will be zero.   |
|           | Unit: mg  |
| Dece.     | The value of deceleration when the vehicle is in motion (for detecting sudden deceleration)   |
|           | When the vehicle is decelerating, the value will be a positive number. And when it is accelerating, the value will be zero.   |
|           | Unit: mg  |
| Turn_Acce | The value of acceleration when the vehicle makes a turn (for detecting sharp turns)   |
|           | When the vehicle is accelerating during a left turn or decelerating during a right turn, the value will be a positive number. When the vehicle is decelerating during a left turn or accelerating during a right turn, the value will be a negative number. |
|           | Unit: mg  |
| Turn_Gyr  | The value of angular velocity when the vehicle makes a turn (for detecting sharp turns and turning directions)  |
|           | When the vehicle turns left, the value will be a positive number. When it turns right, the value will be a negative number.   |
|           | DPS (Radian per Second)   |
| Impact    | Acceleration of vehicle collision (for detecting collision events)  |
|           | Positive number   |
|           | Unit: mg  |
| Filter    | Weight coefficient of acceleration on the Z-axis of impact(collision)   |
|           | Positive number   |

The meanings of “threshold”, “duration”, “status”, “correction” and “sampling frequency” are as follow.

| Items              | Meanings  |
|--------------------|---|
| threshold          | Threshold setting for “Acce”, “Dece”, “Turn_Acce”, “Turn_Gyr”, “Impact” and “Filter”. When the detected value lasts longer than the value set by “duration”, the alarm recording will be triggered. |
| duration           | Detection time setting for “Acce”, “Dece”, “Turn_Acce”, “Turn_Gyr”, “Impact” and “Filter”   |
| status             | Real-time detected value of the corresponding event   |
| correction         | Setting for device installation and G-force data correction   |
| sampling frequency | Sampling frequency of the G-force   |

The threshold and detection duration of alarm triggering recording can be modified to suit various application environments.. The shorter the set detection duration and the lower the set threshold , the higher the sensitivity of alarm triggering will be. The unit of acceleration is mg. (1g≈9.8m/s<sup>2</sup>, 1g=1000mg). The unit of angular velocity is Radian per Second (DPS).

The default values and ranges of thresholds and duration for G-force alarm triggering detection are shown in the table below.

The formula of calculating the acceleration of impact (collision) event is as follow.

|                        | Default | Ranges    |
|------------------------|---------|-----------|
| Acceleration Threshold | 0 mg    | 101~999   |
| Deceleration Threshold | 250 mg  | 101~999   |
| Turn_Acce Threshold    | 250 mg  | 250~999   |
| Turn_Gyr Threshold     | 60 DPS  | 21~99     |
| Impact Threshold       | 1200mg  | 101~19999 |
| Filter                 | 0       | 0~5       |
| Acceleration Duration  | 100ms   | 1~4999    |
| Deceleration Duration  | 100ms   | 1~4999    |
| Turn_Acce Duration     | 100ms   | 1~4999    |
| Turn_Gyr Duration      | 200ms   | 1~4999    |
| Impact Duration        | 100ms   | 1~4999    |

$abs(X) + abs(Y) + abs(Z)*Filter.$

“abs(X)”, “abs(Y)” and “abs(Z)” are the data from the X, Y and Z axes of acceleration sensors in the vehicle. Filter is the coefficient from the Z-axis of acceleration sensors.

Filter rate of Z-axis:

| Sensitivity Level | Filter Rate |
|-------------------|-------------|
| 0                 | 100%        |
| 1                 | 80%         |
| 2                 | 60%         |
| 3                 | 40%         |
| 4                 | 20%         |
| 5                 | 0%          |

Acceleration Sensitivity level and value from Z axis for collision detection (Default level: 0) as shown below.

E.g.: Threshold: 1200 mg; Interval: 100ms

1) Setting sensitivity level: 5

Detection condition:  $\text{abs}(X) + \text{abs}(Y) + \text{abs}(Z) \geq 1200\text{mg}$

2) Setting sensitivity level: 4

Detection condition:  $\text{abs}(X) + \text{abs}(Y) + \text{abs}(Z) \times 0.8 \geq 1200\text{mg}$

3) Setting sensitivity level: 3

Detection condition:  $\text{abs}(X) + \text{abs}(Y) + \text{abs}(Z) \times 0.6 \geq 1200\text{mg}$

4) Setting sensitivity level: 2

Detection condition:  $\text{abs}(X) + \text{abs}(Y) + \text{abs}(Z) \times 0.4 \geq 1200\text{mg}$

5) Setting sensitivity level: 1

Detection condition:  $\text{abs}(X) + \text{abs}(Y) + \text{abs}(Z) \times 0.2 \geq 1200\text{mg}$

6) Setting sensitivity level: 0

Detection condition:  $\text{abs}(X) + \text{abs}(Y) \geq 1200\text{mg}$

The default values are detected as follow.

(1) If the vehicle accelerates continuously in the positive direction of the X-axis and the real-time value of Acce exceeds the threshold continuously for 100ms during driving, an alarm of Acceleration will be triggered by the device.

- (2) If the vehicle decelerates continuously (brakes suddenly) in the positive direction of the X-axis and the real-time value of Dece exceeds the threshold continuously for 100ms during driving, an alarm of Deceleration will be triggered by the device.
- (3) If the vehicle quickly turns to the positive direction of Y-axis and the real-time value of Turn Acce exceeds the threshold continuously for 100ms during driving, an alarm of Turn\_Acce will be triggered by the device.
- (4) If the vehicle quickly turns to the opposite direction of Y-axis and the real-time value of Turn Acce exceeds the threshold continuously for 100ms during driving, an alarm of Turn Acce will be triggered by the device.
- (5) If the vehicle quickly turns to the positive or opposite direction of Y axis and the real-time value of Turn Gyr exceeds the threshold continuously for 100ms during driving, an alarm of Turn Gyr will be triggered by the device.

- Introduction to Installation and Calibration of the device

There are various installation methods when installing the DVR into the vehicle, since the DVR has a different coordinate system from the vehicle itself. The device coordinate system is shown in the figure below. The X-axis refers to the front side of the device (the side with LED lights). The Y-axis represents the left side of the device (the side without a lock). And the Z-axis corresponds to the vertically upward direction when the device is installed.

**Z-axis** (in vertical upward direction)

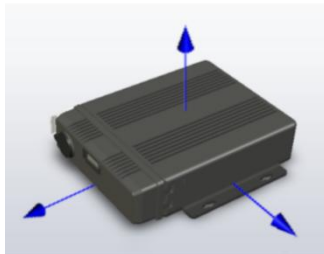

**X-axis** (the side with LED light)

**Y-axis** (the side without lock)

The vehicle coordinate system is shown in the figure below. In the coordinate system, the forward direction of vehicle is set as Forward axis and the left direction of vehicle is set as Left axis. There are multiple possible ways to install the device.



Forward

Left



As shown in the figure below, there may be multiple installation positions for the device. In addition, there might be a slight tilt in the device installation process. So it requires calibration with the data from G-force.



- Device Installation Method Selection and Installation Correction

Forward and Left refer to the forward and the left direction of vehicle movement respectively. They help determine the direction of the vehicle by the corresponding axes of the device, which is used to determine the installation method of the device.

Click the “Forward” and “Left” buttons to set the axis direction of the device relative to the vehicle. For example, if “Forward” is set to “+X” and “Left” is set to “+Y”, it means when the vehicle is moving forward, the forward direction of the device is the positive direction of the X-axis of the device. If “Forward” is set to “-Z” and “Left” is set to “+Y”, it means that when the vehicle is moving forward, the forward direction of the device is the opposite direction of the Z-axis and the positive Y-axis direction of the device is the left direction of the vehicle, that is to say, the device is vertically installed on the vehicle and its bottom is facing the front of the vehicle.

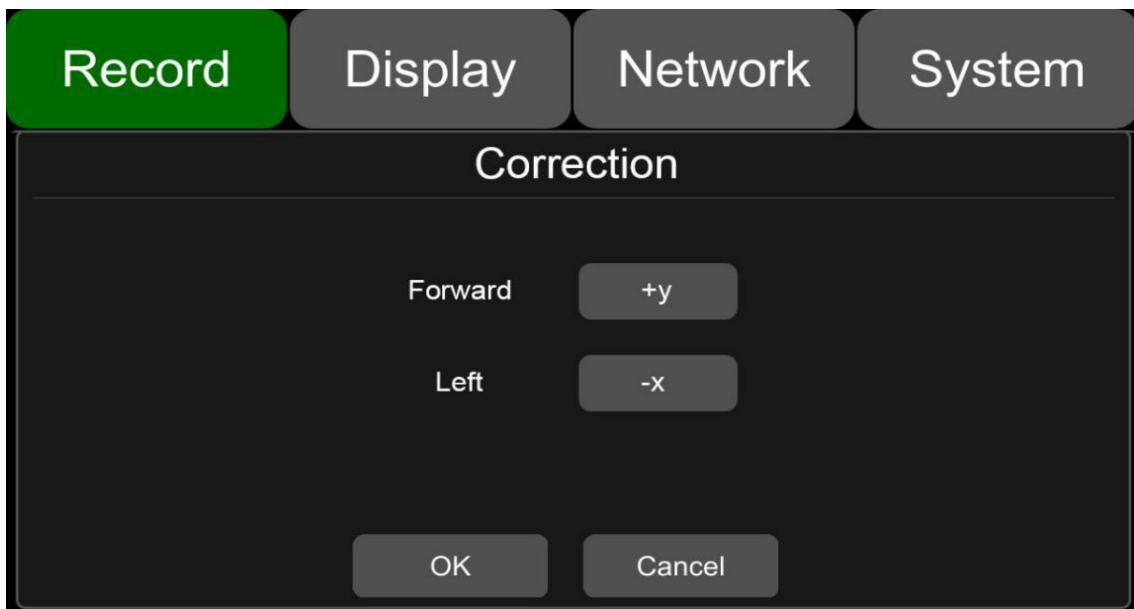

When the setting is finished, click the button “OK” to exit the interface. Please ensure that the vehicle stays still for more than 1s after the setting is finished, so that the system can apply the calibration procedure. When the data of Status (real-time sensor data) is observed to change to close to 0, it indicates that the calibration procedure is complete.

**WARNING:** The device installation must be calibrated before being put into use. During the calibration process, the vehicle must be parked on a flat area in a static position and the calibration time shall not be less than 1s.

When the device is installed for the first time or reinstalled, the installation position should be re-selected and re-calibrated if the installation position has changed significantly.

## 8.11 File Type



Set video format. Record video files in AVI format by default.

## 8.12 Record Audio



Set the recording audio of the channel. When a recording channel is selected, the audio from that channel will be included in the recording file. If a channel is not selected, there will be no audio recorded for the recording file of that particular channel. The default configuration is shown below.

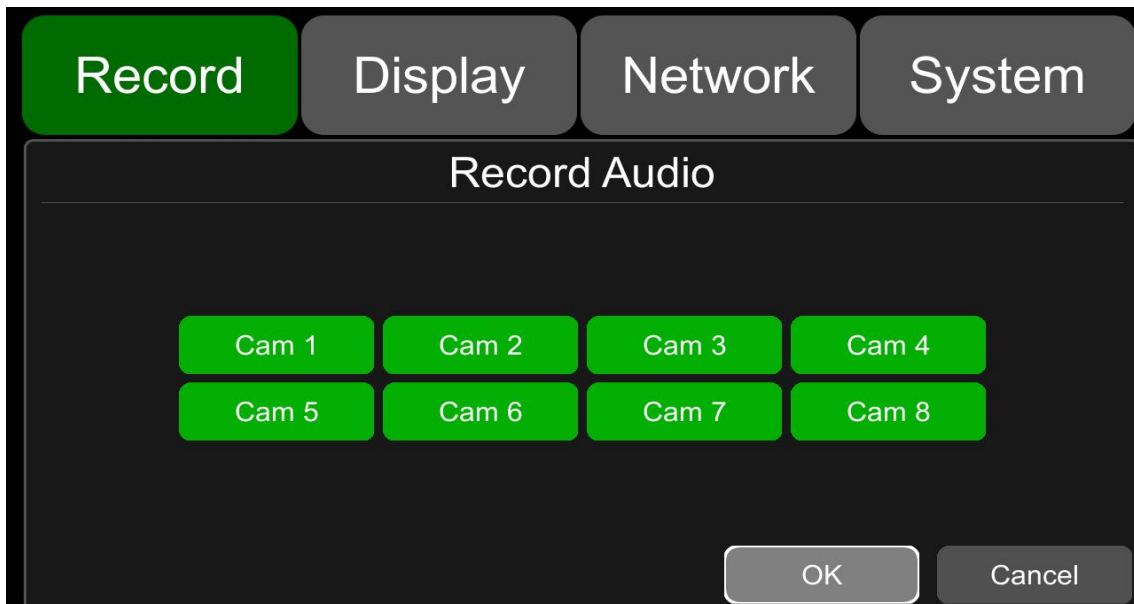

# 9 Display

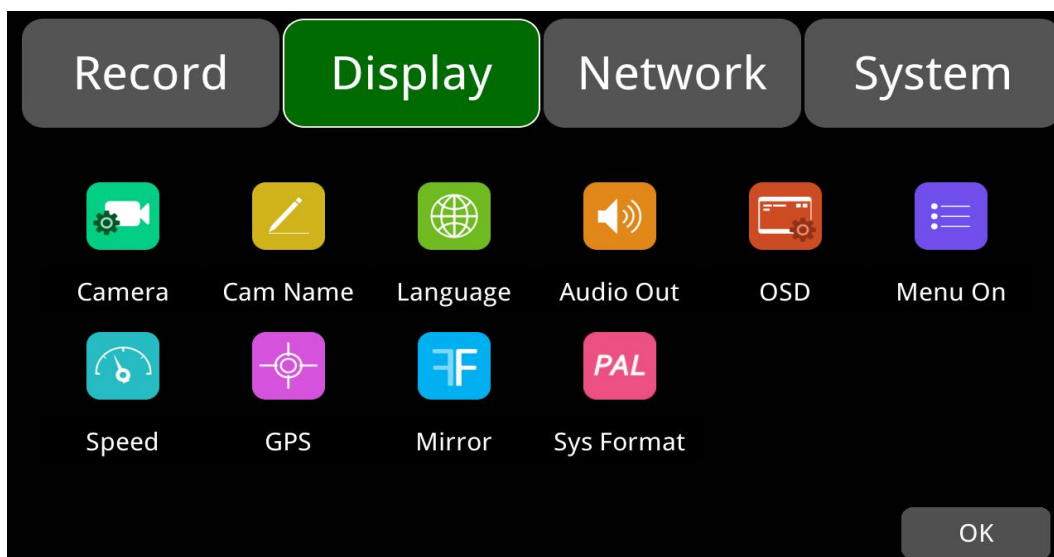

## 9.1 Camera Display Setting



Camera parameter setting for each corresponding channel includes brightness, contrast, saturation and hue. The default values of brightness, contrast, saturation and hue of all channels are shown in the figure below. To change the value, drag the bar to left or right to decrease or increase.

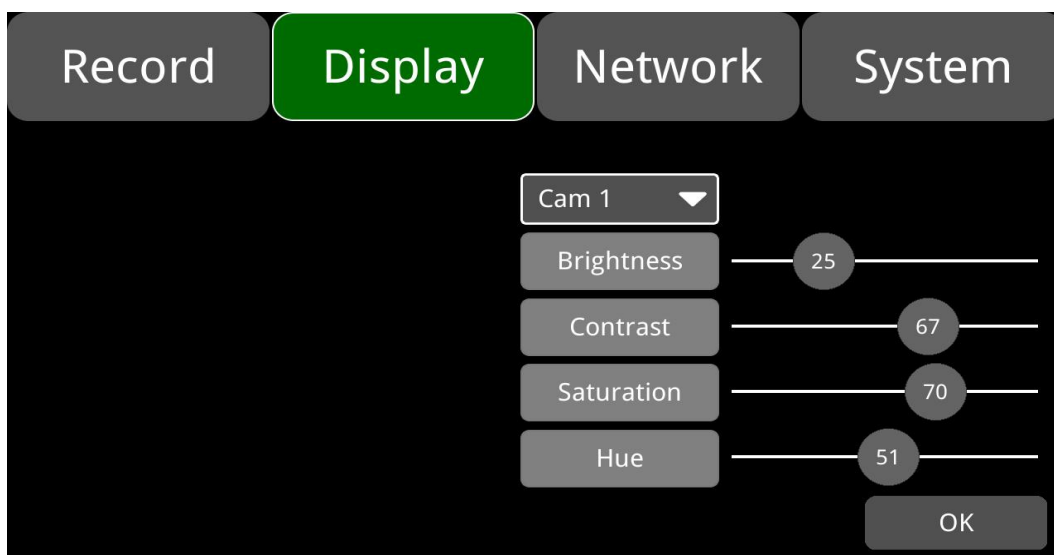

| Camera Display | Min. | Max. | Default |
|----------------|------|------|---------|
| Brightness     | 0    | 99   | 25      |
| Contrast       | 0    | 99   | 67      |
| Saturation     | 0    | 99   | 70      |
| Hue            | 0    | 99   | 51      |

## 9.2 Camera Name Setting



Camera Names are displayed at the bottom of each channel.

Touch the “Display->Camera Name->CamX” on the menu, a keyboard will pop up to input a new camera name.

**Note:** Maximum 8 characters can be entered and the camera name must NOT be blank. The default configuration is shown below.

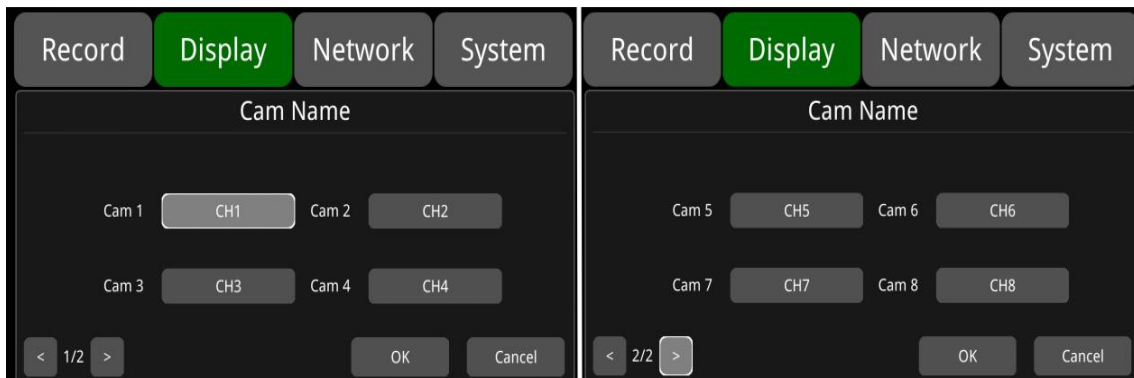

## 9.3 System Language Setting



Menu languages: English, Russian, Turkish, Chinese, Japanese, Spanish, Portuguese, French. The default language is English.



## 9.4 Audio Out



Select the audio output channel in multi-display mode. The default configuration is shown below.

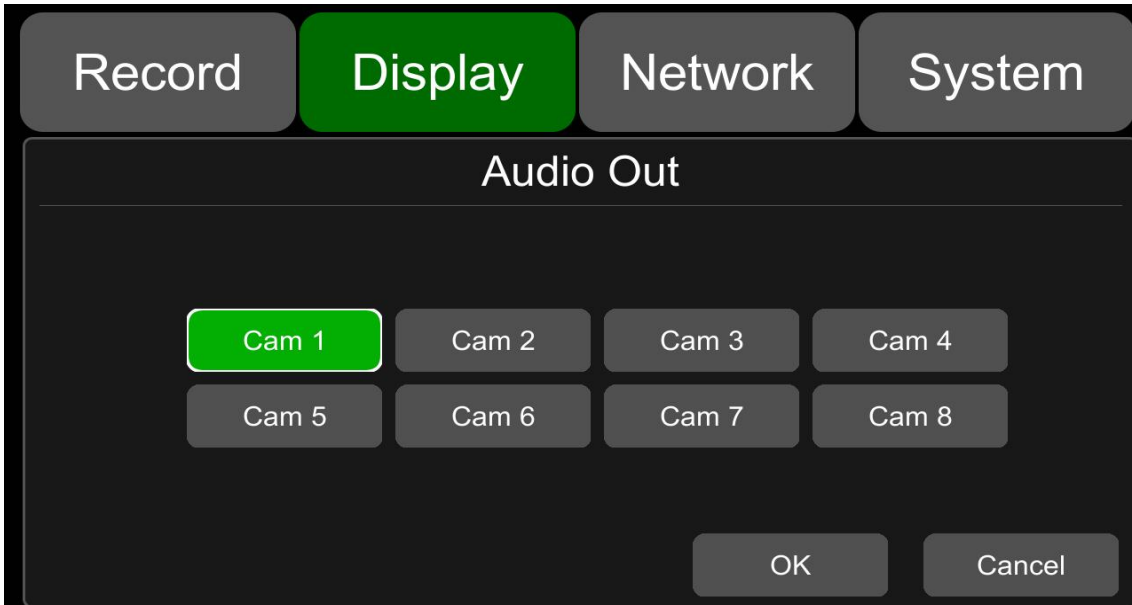

## 9.5 OSD Display Setting



Time, Camera name, License number and Speed can be selected whether to display or not. If it is ON, the information will be shown in the live and the playback video. The default configuration is shown below.

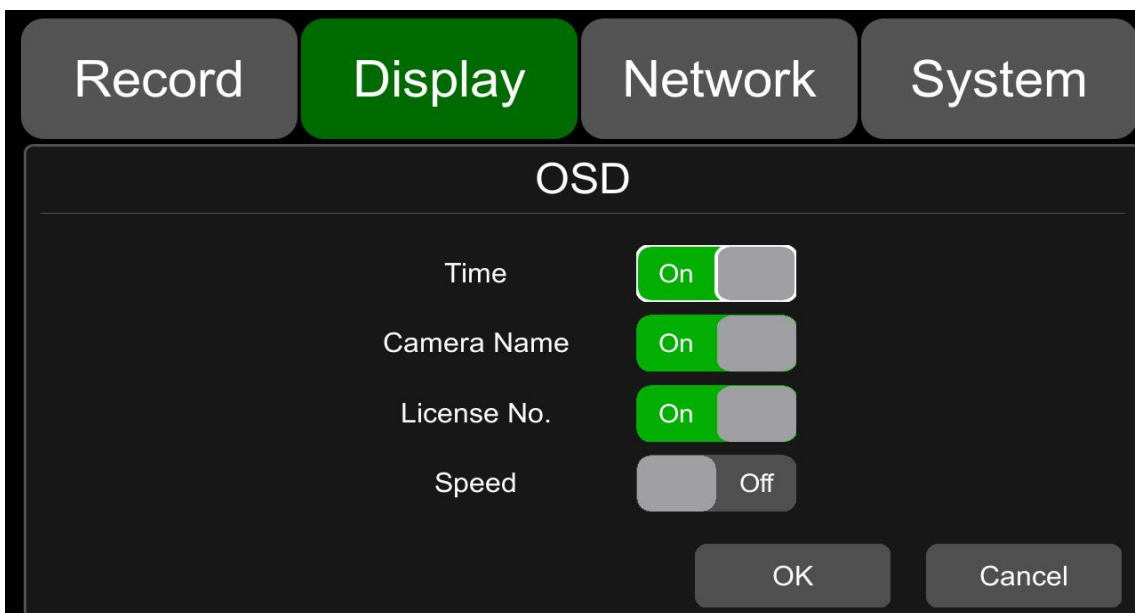

## 9.6 Menu On



Setting of menu display duration. The default configuration is shown below.

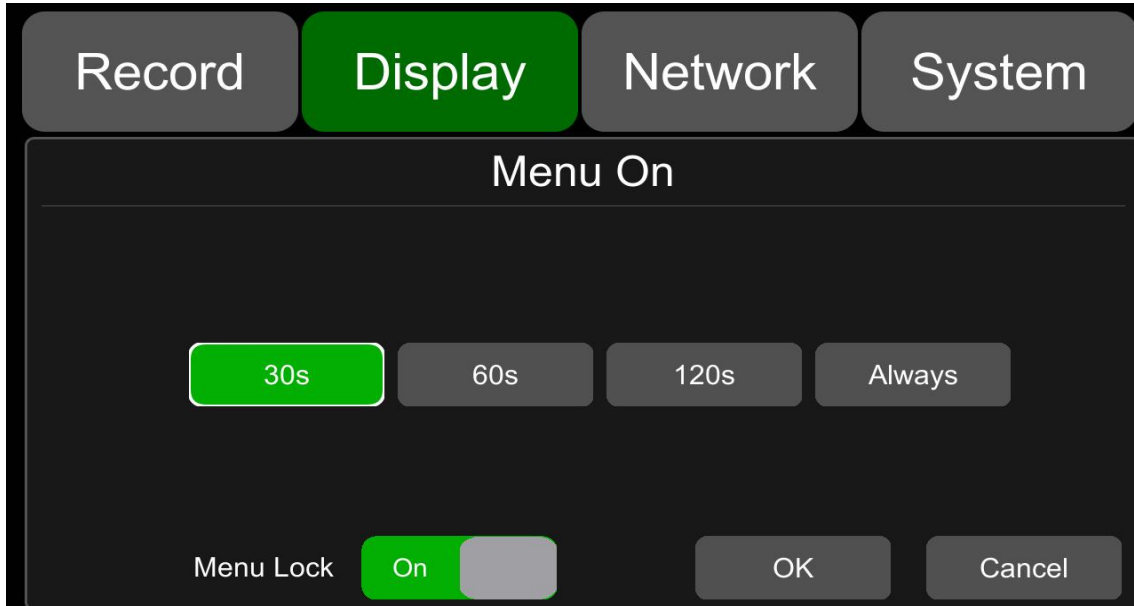

**Menu on:** Duration can be set to 30s, 60s, 120s and Always. When it is set to 30s, 60s, 120s, it means that the menu will disappear if there is no operation within 30s, 60s or 120s. When it is set to Always, the menu will always be there. Please note that the recording will stop when the menu is on. It is not suggested to set it to Always in order not to affect the recording.

**Menu lock:** When it is ON, permission is required to enter the menu.

When it is Off, no permission is required to enter the menu.

The username “admin” and password are required to change the status of the menu lock.

## 9.7 Speed



Speed setting: The data source of overspeed comes from GPS. Speed unit is optional: Km/h or Mile/h.

Overspeed threshold can be set by users. Speed refers to the current speed of the vehicle. Duration is the setting of the overspeed alarm time. If the speed exceeds the value of the overspeed, the overspeed alarm recording will be triggered.

The alarm switch is to set the overspeed alarm recording to “On” and “Off”. If it is ON, the overspeed alarm recording will be triggered when the vehicle is overspeed. If it is OFF, the overspeed alarm recording will not be triggered. The default configuration of each item is as follows.

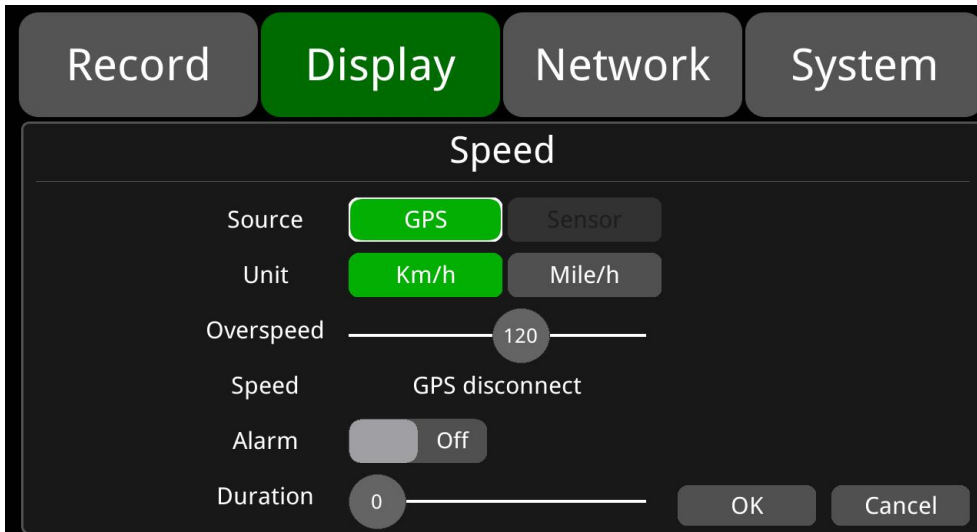

| Overspeed | Min. | Max. | Default |
|-----------|------|------|---------|
| Km/h      | 0    | 200  | 120     |
| Mile/h    | 0    | 125  | 75      |

## 9.8 GPS



When the GPS antenna is properly installed, the latitude, longitude and speed will be recorded. The menu provides the GPS information including latitude, longitude, detectable satellites, and accessible satellites etc.

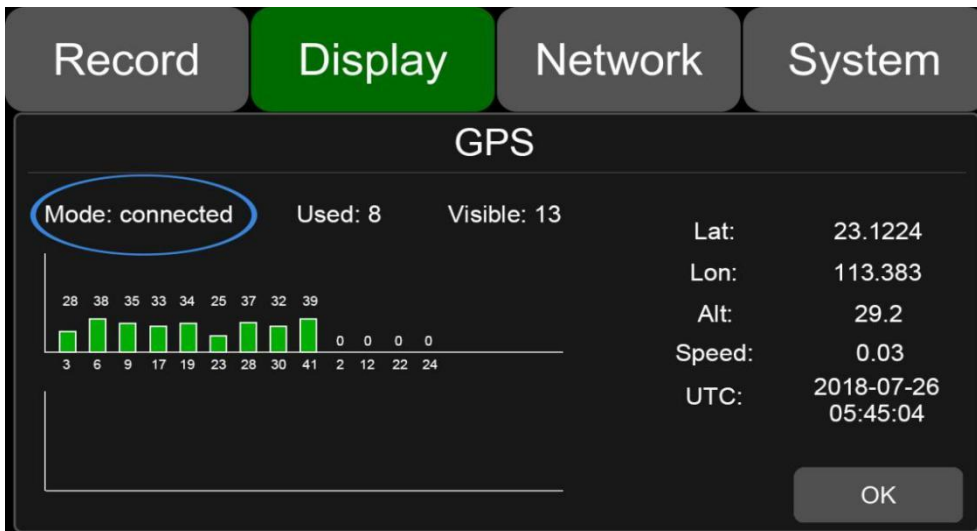

**Mode:** indicates the GPS connection status.

**Used:** indicates the number of available satellites.

**Visible:** indicates the number of searchable satellites.

## 9.9 Mirror



Horizontal and vertical flips of all channels are turned off by default.

Horizontal: when it is set to “On”, the corresponding recording channel will flip horizontally; when it is set to OFF, no horizontal flip will be done.

The setting steps are shown as follows.

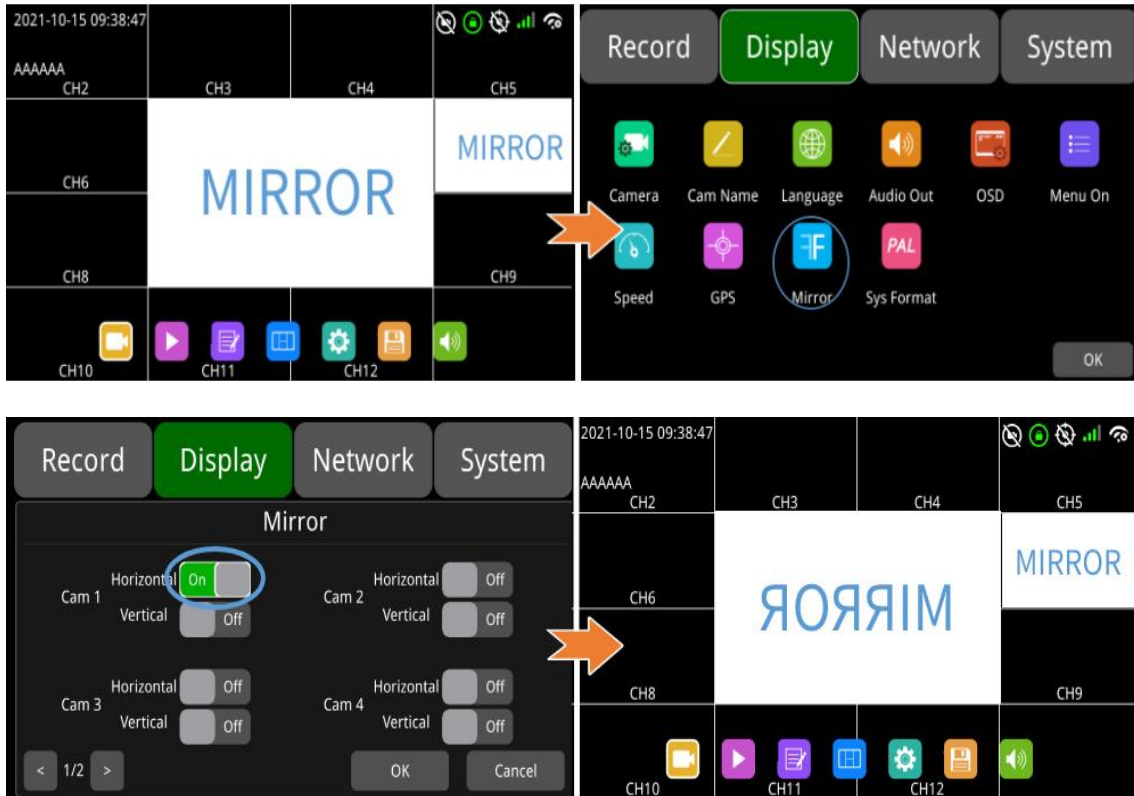

**Vertical:** When it is set to “On”, the corresponding recording channel will flip vertically; when it is set to “Off”, no vertical flip will be done. The setting steps are shown as follows.

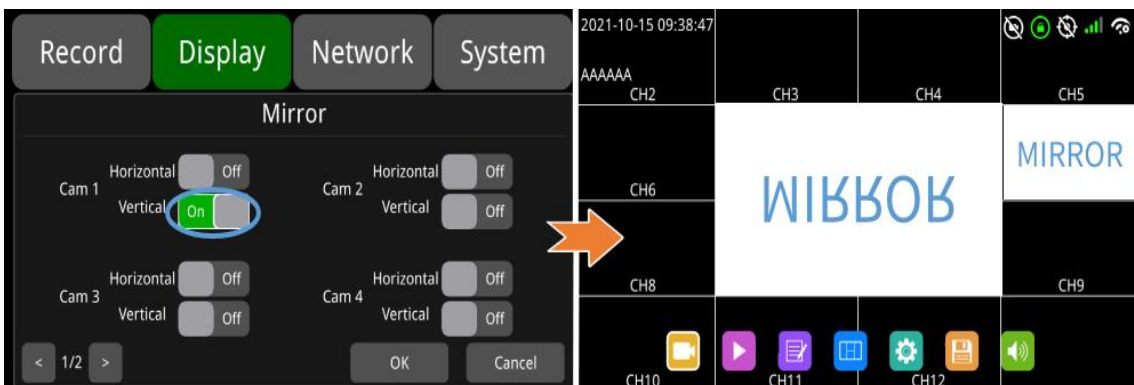



## 9.10 System Format Setting

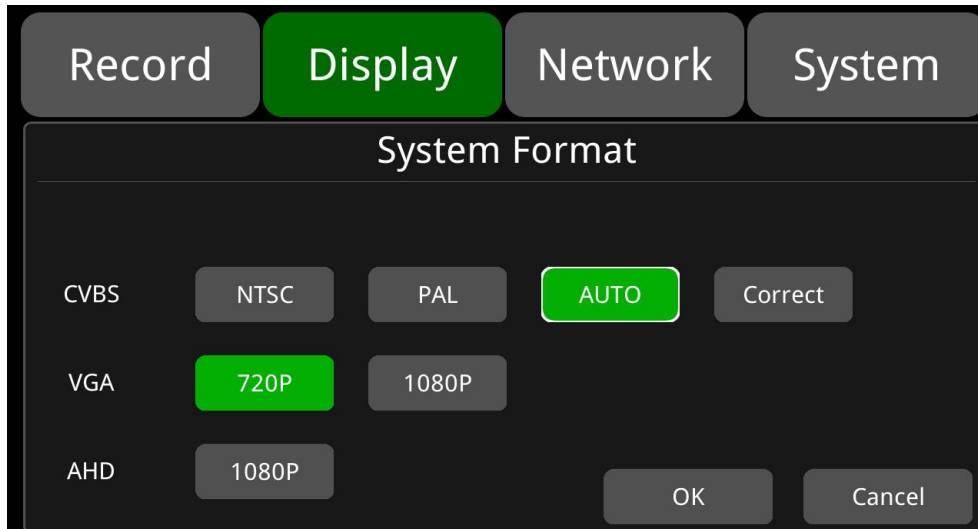

The default configuration is shown above.

**CVBS:** Standard definition display.

**VGA:** HD display.

**AHD:** HD display.

Note: CVBS/VGA can be displayed together. AHD cannot be displayed together with CVBS/VGA, and only one of them can be displayed.

**Correct:** When the interface of the standard definition display on the screen is not fully displayed, it can be reduced in size. Each reduction unit equals two pixels, and a maximum of 64 units can be reduced.

When the interface is minimized, the DVR can only be operated using the remote control.

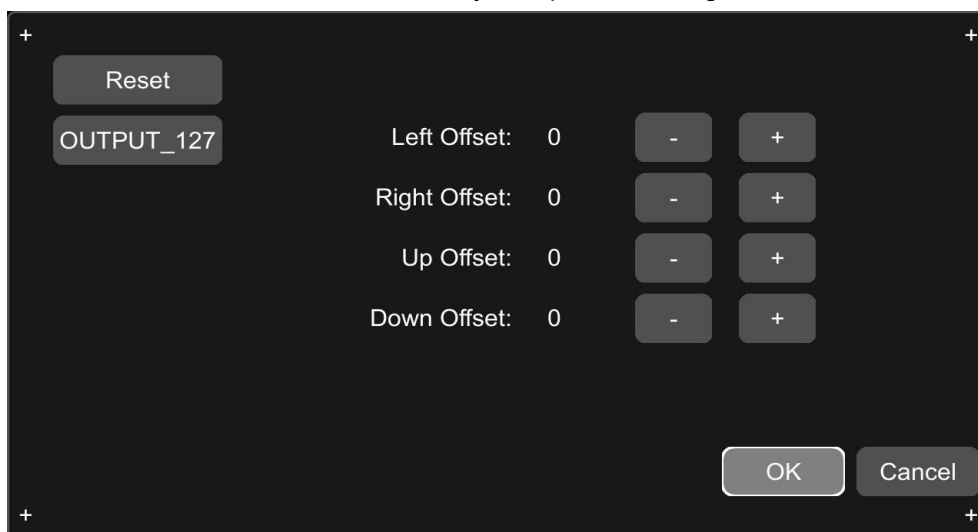

The default configuration is described in the following table.

| OUTPUT_127 | Left Offset | Right Offset | Up Offset | Down Offset |
|------------|-------------|--------------|-----------|-------------|
| Default    | 30          | 28           | 12        | 10          |

| Correct      | Min. | Max. | Default |
|--------------|------|------|---------|
| Left Offset  | 0    | 64   | 0       |
| Right Offset | 0    | 64   | 0       |
| Up Offset    | 0    | 64   | 0       |
| Down Offset  | 0    | 64   | 0       |

## 9.11 Radar Setting



Radar can be connected to ultrasonic radar and 77G microwave radar

### Radar wiring diagram

The DVR can be connected to the BSA09 control box via RS232/485 to 232, and to the 77G microwave radar via CAN.

**BSA09:** Through RS232, the DVR can be connected to the BSA09 radar control box. BSA09 radar control box has the capability to connect with up to 12 channels of ultrasonic radar probes, as shown in the figure below.

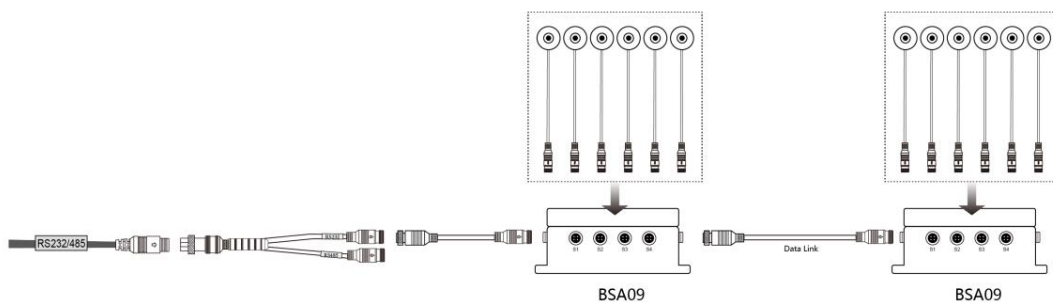

BSA09 radar control box connection diagram

**77G:** it connects to a CAN BUS, there are old and new solutions, the old solutions can connect up to 2 77G radar, the new solutions can connect up to 4 77G microwave radar, connect more than 2 77G microwave radar, the radar needs external power supply, The maximum length of the connection line is 25 meters.

The following figure shows the wiring of the old solution:

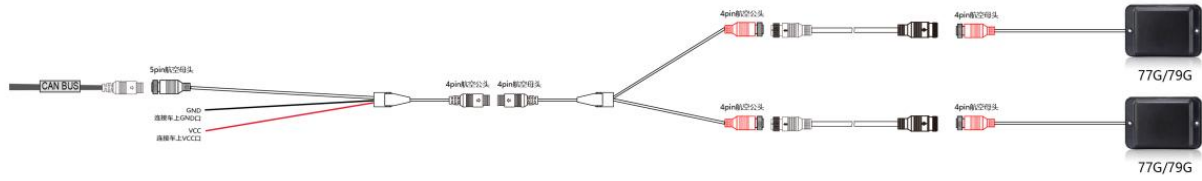

77G microwave radar connection diagram (old)

The following figure shows the wiring of the new solution:

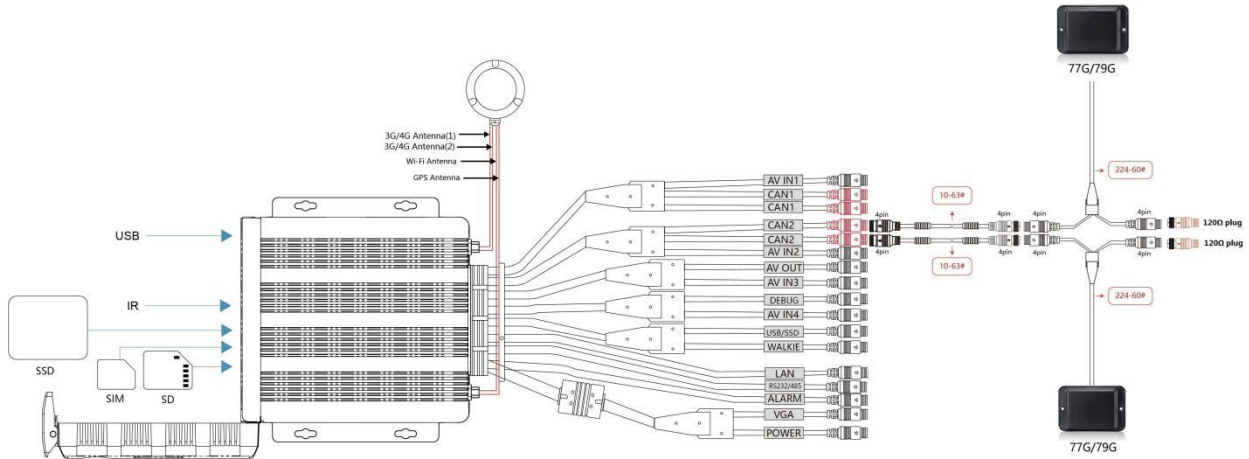

77G microwave radar 1~2 channels connection diagram 1 (new)

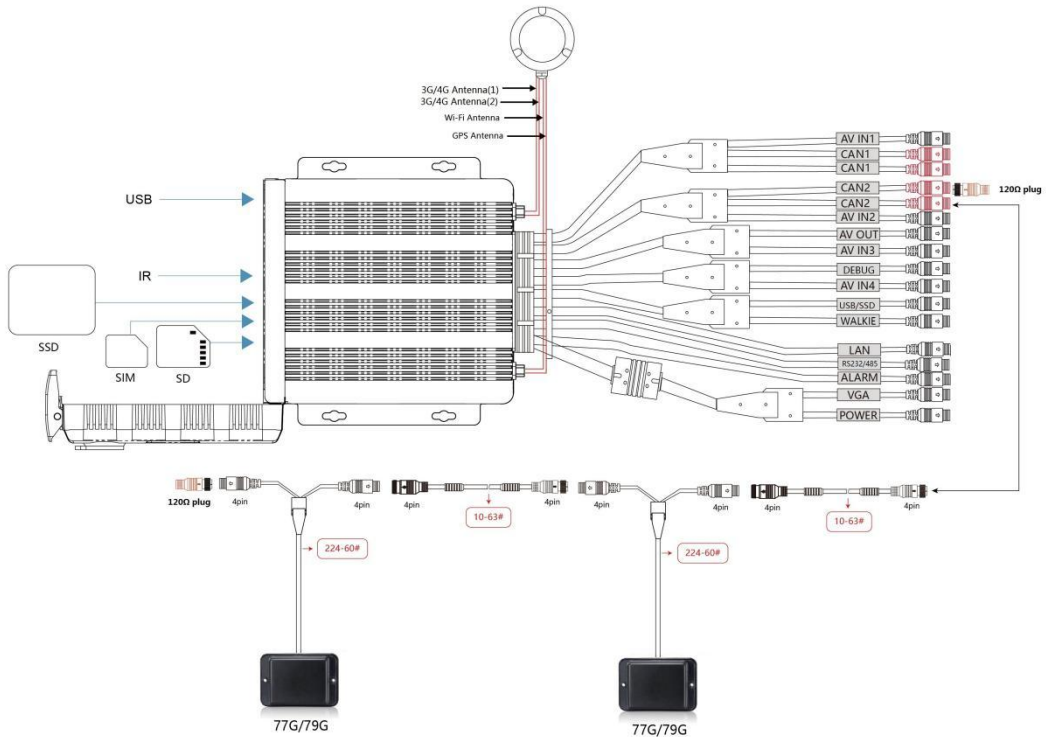

77G microwave radar 1~2 channels connection diagram 2 (new)

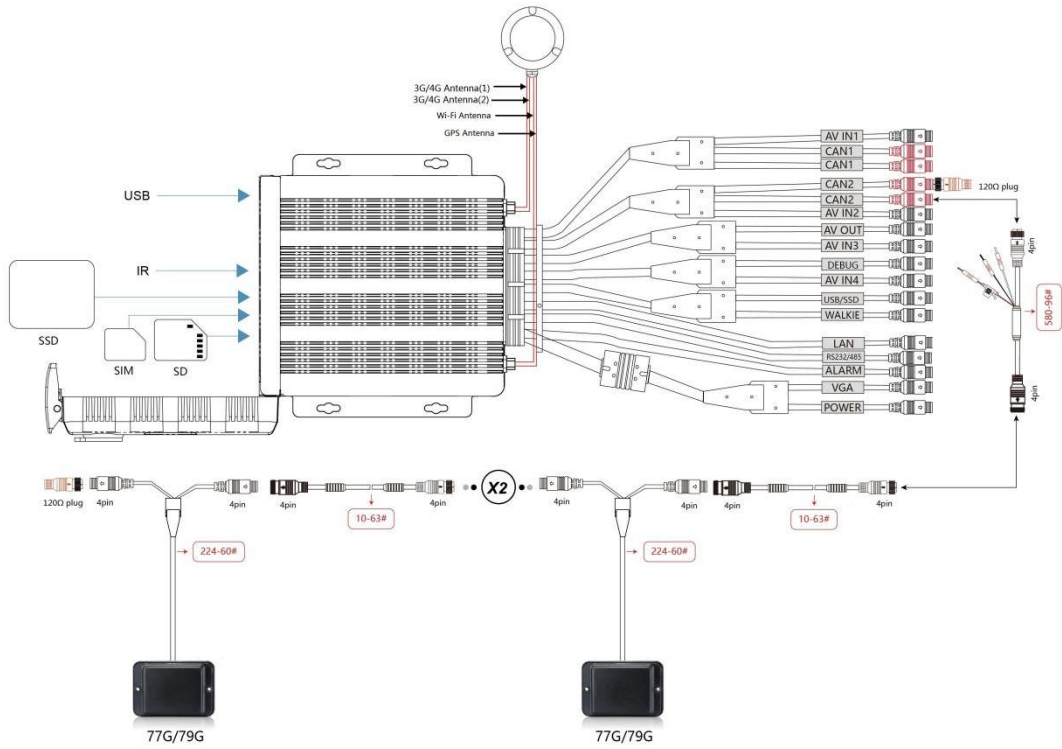

77G microwave radar 3~4 channels connection diagram 1 (new)

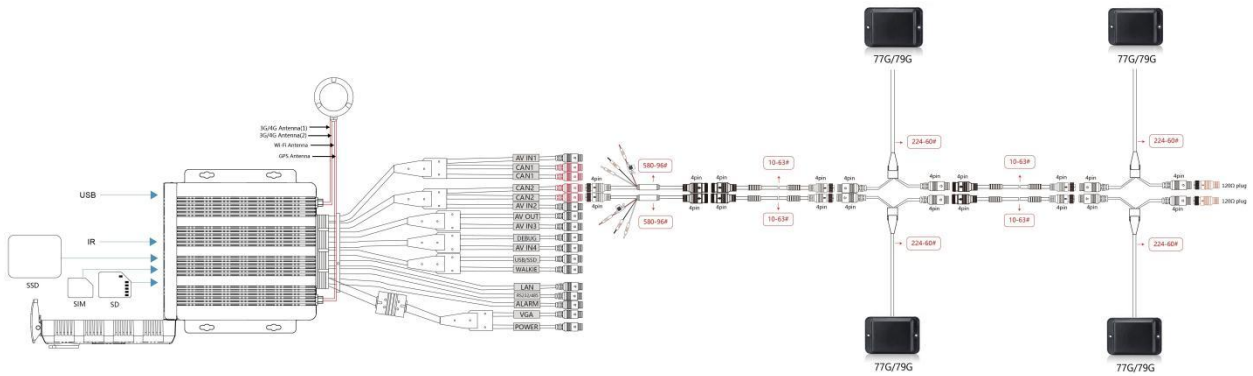

77G microwave radar 3~4 channels connection diagram 2 (new)

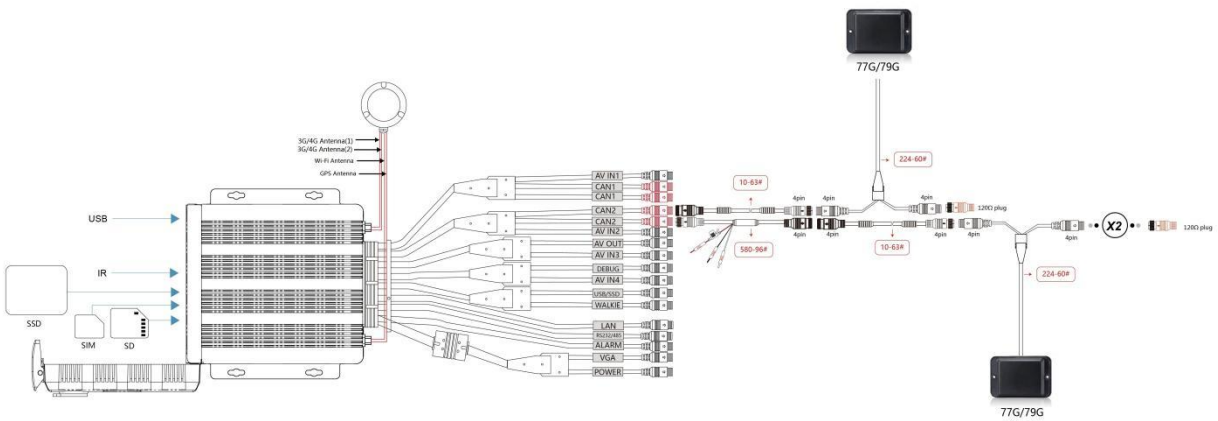

77G microwave radar 3~4 channels connection diagram 3 (new)

## Configuration Interface and Functions

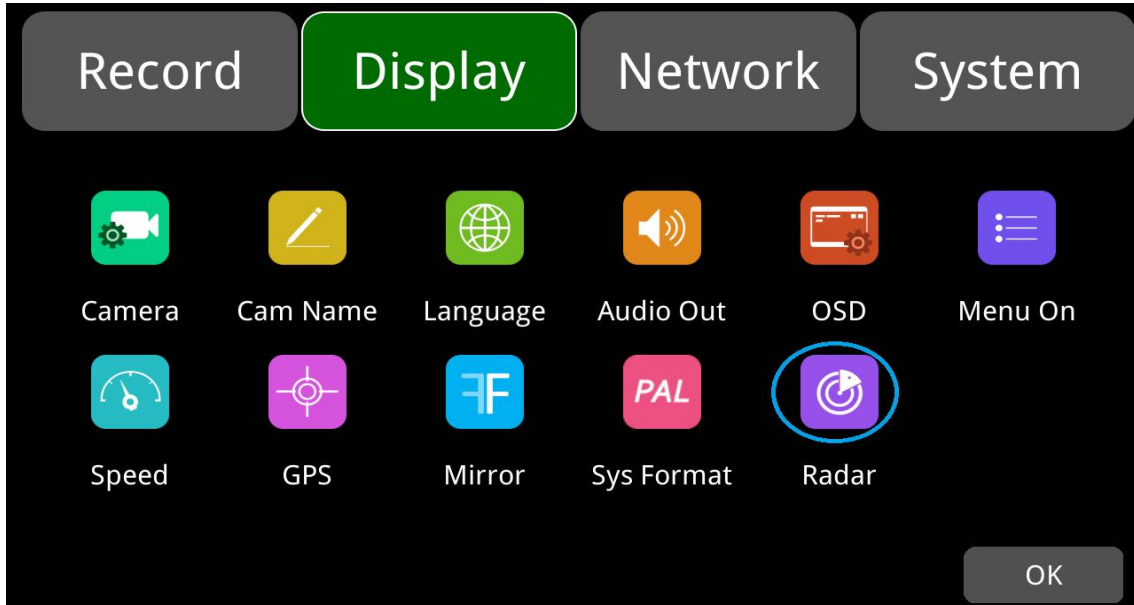

- Ultrasonic Radar

Ultrasonic radar has high accuracy in detecting distances within the range of 0.1~3 meters. It is also characterized by its affordability, strong penetration capabilities, and excellent waterproof and dustproof abilities. Through the BSA09 radar control box, up to 12 probes of ultrasonic radar can be accessed. All-round monitoring of the car body is realized.

**Ultrasound:** ultrasonic radar (up to 12 probes).

The screenshot shows the 'Ultrasonic' configuration screen. On the left is a diagram of a car with 12 numbered radar sensors around it. On the right is a table with columns: No., Bind, Position, Distance-Alarm (m), Distance-Warn (m), Display, Switch, Priority, and Screen. The table lists 12 probes with their respective settings.

| No. | Bind | Position | Distance-Alarm (m) | Distance-Warn (m) | Display | Switch | Priority | Screen  |
|-----|------|----------|--------------------|-------------------|---------|--------|----------|---------|
| 1   | None | Left1    | 1.00               | 2.00              | L radar | Enable | 1        | Disable |
| 2   | None | Left2    | 1.00               | 2.00              | L radar | Enable | 2        | Disable |
| 3   | None | Left3    | 1.00               | 2.00              | L radar | Enable | 3        | Disable |
| 4   | None | Right1   | 1.00               | 2.00              | R radar | Enable | 4        | Disable |
| 5   | None | Right2   | 1.00               | 2.00              | R radar | Enable | 5        | Disable |
| 6   | None | Right3   | 1.00               | 2.00              | R radar | Enable | 6        | Disable |
| 7   | None | Front1   | 1.00               | 2.00              | F radar | Enable | 7        | Disable |
| 8   | None | Front2   | 1.00               | 2.00              | F radar | Enable | 8        | Disable |
| 9   | None | Front3   | 1.00               | 2.00              | F radar | Enable | 9        | Disable |
| 10  | None | Back1    | 1.00               | 2.00              | B radar | Enable | 10       | Disable |
| 11  | None | Back2    | 1.00               | 2.00              | B radar | Enable | 11       | Disable |
| 12  | None | Back3    | 1.00               | 2.00              | B radar | Enable | 12       | Disable |

① **No.:** The radar probe number.

② **Bind:** "Alarm in" trigger: The radar is automatically activated when the vehicle driving status is switched, through which accurate detection is ensured. Take reverse rear view radar as an example. Alarm in of the device will be triggered when the vehicle is reversing, then the rear view radar function will be started. The rear view radar stops when the vehicle is moving forward.

③ **Position:** Referring to the motor vehicle signs on the left side in the above two figures, there are a

total of 16 mounting positions to choose from. There are four installation positions available for each orientation (front, rear, left and right). The radar position is displayed in real time in the OSD content at the top left of the screen (to be developed).

④ **Distance-Alarm(m)**: Alarm distance setting. When the distance between the detected object and the probe is below the set alarm distance, an alarm beep will be issued, with a default alarm distance of 1m. The optional alarm distance of ultrasonic radar ranges from 1~2m, with a 0.2-meter interval between each option. Additionally, the microwave radar allows for optional settings of both alarm distance and warning distance within the range of 0.5~40m.

⑤ **Distance-Warn(m)**: Warning distance setting. When the distance between the detected object and the probe is below the set warning distance but higher than the alarm distance, a warning beep will be emitted. with a default warning distance of 2m. Yet the frequency of the warning beep is more moderate compared to that of the alarm beep. For ultrasonic radar, the range of warning distances extends from 1 to 5 meters. As for microwave radar, the optional setting range for warning distances spans from 0.5 to 40 meters. If the distance between the detected object and the probe exceeds the warning distance, no alarm will be generated.

⑥ **Display**: The configuration of switching preview video display mode after an alarm or warning trigger. Currently, 25 split display modes are available.

⑦ **Switch**: Whether to enable a specific radar probe. If one is disabled, the warning triggered by it will also be turned off (including audio, screen explosion, distance display, alarm, etc.).

⑧ **Priority**: The priority between multiple radar monitoring. If multiple radars alarm at the same time, the priority is set to the radar with a higher priority.

⑨ **Screen**: Warning mode configuration. When set to Enable, a red screen explosion effect is generated when the alarm is triggered, and a yellow screen explosion effect is generated when the warning is triggered; on the other hand, selecting the Disable option will prevent any screen explosion effects from being displayed.

- **77G Microwave Radar**

Microwave radar has a strong penetration capability and a better anti-interference performance through various environments, especially in foggy and dusty times, with a detection distance of up to 200 meters. And for microwave radar between different frequency bands, compared with 24G band, 77G band has the advantage of high available equivalent omnidirectional radiated power for front-end remote radar applications. 77G band is widely utilized in Japan and Europe for basic transportation infrastructure systems, and 77G microwave radar is becoming a trend. Most importantly, MDVR incorporates 77G microwave radar for various applications such as early warning systems and blind spot detection.

| Ultrasonic |      | Microwave |                     |                    |                     |         |        |          |         |  |  |
|------------|------|-----------|---------------------|--------------------|---------------------|---------|--------|----------|---------|--|--|
| No.        | Bind | Position  | Distance- Alarm (m) | Distance- Warn (m) | Detection width (m) | Display | Switch | Priority | Screen  |  |  |
| 0          | None | Left1     | 1.00                | 2.00               | 2.80                | L (CH1) | Enable | 1        | Disable |  |  |
| 1          | None | Left2     | 1.00                | 2.00               | 2.80                | L (CH1) | Enable | 2        | Disable |  |  |
| 2          | None | Left3     | 1.00                | 2.00               | 2.80                | L (CH1) | Enable | 3        | Disable |  |  |
| 3          | None | Right1    | 1.00                | 2.00               | 2.80                | R (CH2) | Enable | 4        | Disable |  |  |
| 4          | None | Right2    | 1.00                | 2.00               | 2.80                | R (CH2) | Enable | 5        | Disable |  |  |
| 5          | None | Right3    | 1.00                | 2.00               | 2.80                | R (CH2) | Enable | 6        | Disable |  |  |
| 6          | None | Front1    | 1.00                | 2.00               | 2.80                | F (CH3) | Enable | 7        | Disable |  |  |
| 7          | None | Front2    | 1.00                | 2.00               | 2.80                | F (CH3) | Enable | 8        | Disable |  |  |
| 8          | None | Front3    | 1.00                | 2.00               | 2.80                | F (CH3) | Enable | 9        | Disable |  |  |
| 9          | None | Back1     | 1.00                | 2.00               | 2.80                | B (CH4) | Enable | 10       | Disable |  |  |
| 10         | None | Back2     | 1.00                | 2.00               | 2.80                | B (CH4) | Enable | 11       | Disable |  |  |
| 11         | None | Back3     | 1.00                | 2.00               | 2.80                | B (CH4) | Enable | 12       | Disable |  |  |

**Detection width (m):** detection distance configuration. Detection distance can be set in the range of 0.6~20m, with a default configuration of 2.8m.

- Warning Mode

1. **Visual warning:** screen explosion effect. Both single-radar and multi-radar are available.

- When the monitoring target enters the alarm distance range, the screen displays a red fading box as an emergency alert.
- When the monitoring target enters the warning distance range, the screen displays a yellow fading box as a warning prompt.
- Radar position and obstacle detection distance are displayed.
- Support customization of any visual warning effect for the customer.

The effect is shown in the following figure:

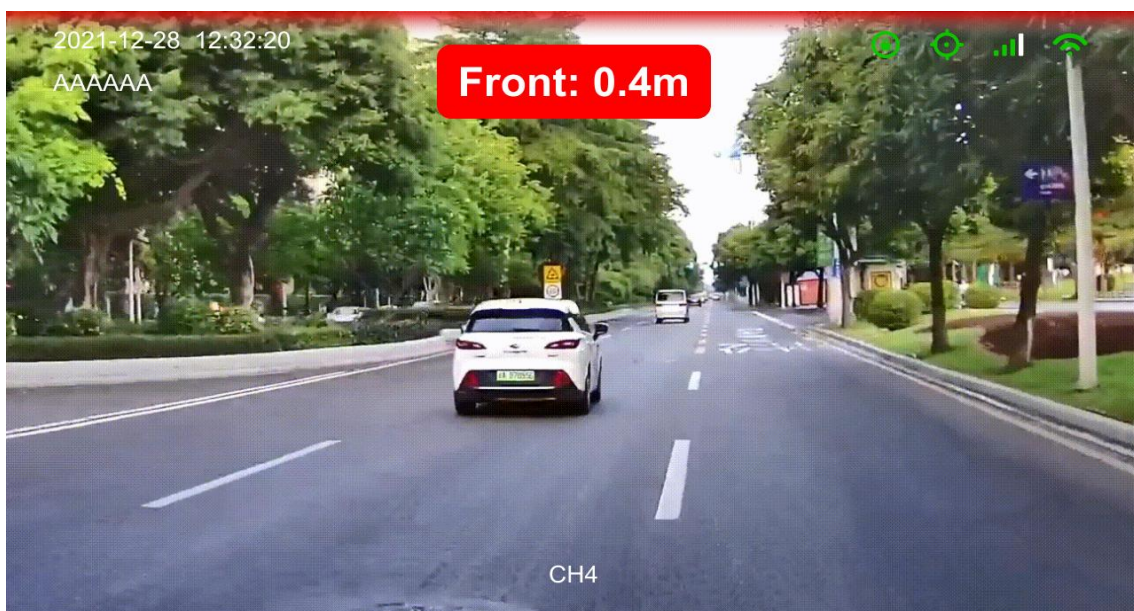

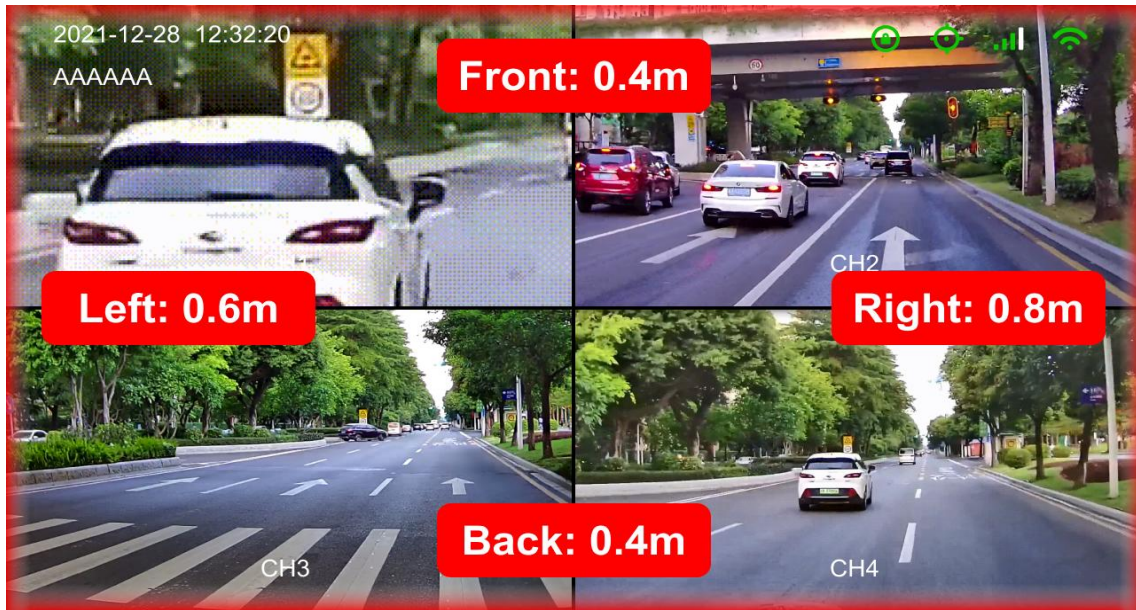

The screen explosion effect of the preview interface

2. **Audible warning:** alert by “beep” tone.

- If the monitoring target enters the alarm distance range, the sound frequency is relatively higher.
- If the monitoring target enters the warning distance range, the sound frequency is relatively low.
- Support voice broadcasting of collision-prone positions, including the front, back, left, and right directions.
- Support customization of any audible warning effect for users.

3. **Remote warning:** When the warning condition is reached, a pop-up box will appear on the remote CMS Client to remind the administrator that a collision alarm exists for the vehicle. As shown in the bottom right corner of the figure below, an Alarm pop-up window with its type named “radar” will appear.





## 10 Network

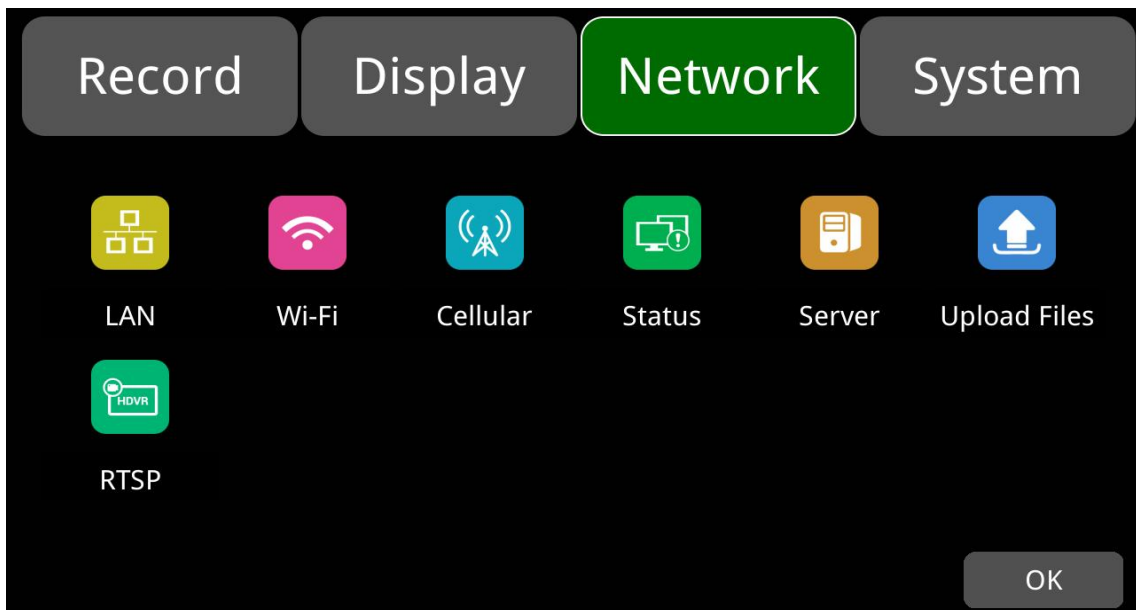

## 10.1 LAN and Server Setting



| LAN     |                              |
|---------|------------------------------|
| DHCP    | <input type="checkbox"/> Off |
| IP      | 192.168.31.88                |
| Mask    | 255.255.255.0                |
| Gateway | 192.168.31.1                 |
| MAC     | 7E:97:15:D3:21:7A            |

The default configuration is shown above.

- **DHCP:** Dynamic Host Configuration Protocol. Set ON for dynamic IP and Off for static IP. Static IP must be manually input with IP address, Mask and Gateway. MAC address can be automatically assigned or revised.
- **LAN connection**

**Step 1:** Connect the LAN cable to the DVR.

**Step 2:** Go to “Network - >LAN” page.



**Step 3:** If DHCP is set to “On”, a dynamic IP will be automatically matched. If DHCP is set to “Off”, input the IP, Mask, Gateway and MAC manually.

**Step 4:** Touch OK to save and exit.

**Step 5:** Go to “Network - Server” page and touch the LAN icon.

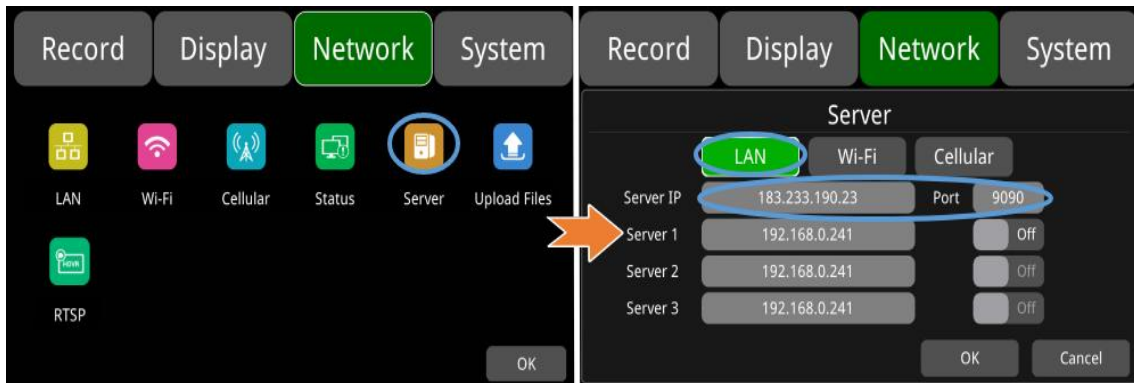

**Step 6:** Input LAN Server IP and Port. Touch OK to save the settings.

## 10.2 Wi-Fi Network and Server Setup

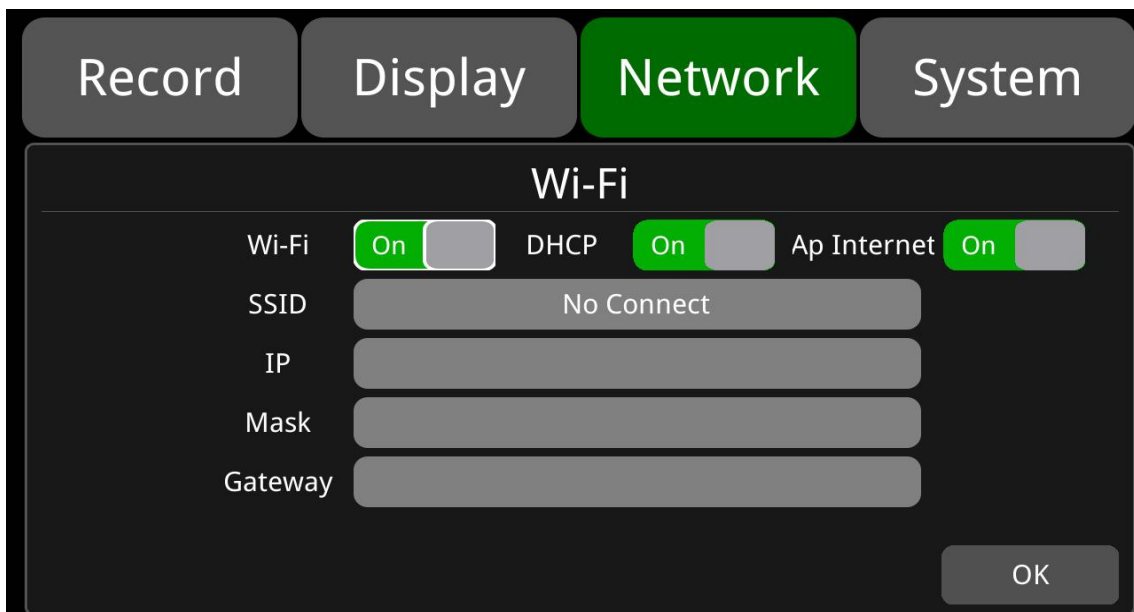

The default configuration is shown above.

**DHCP:** Dynamic Host Configuration Protocol. Set ON for dynamic IP and Off for static IP. Static IP must be manually input with IP address, Mask and Gateway.

**SSID:** Wi-Fi hotspot list.

**AP Internet:** The hotspot of the device can be found on mobile phones when it is ON.

- **Wi-Fi connection**

**Step 1:** Make sure Wi-Fi hotspot is available.

**Step 2:** Connect the Wi-Fi antenna to connector ③ of the rear panel of the device.

**Step 3:** Go to Wi-Fi setup interface, set Wi-Fi to “On” and DHCP to “On”.



**Step 4:** Touch SSID sub-menu to select the hotspot and input the password.

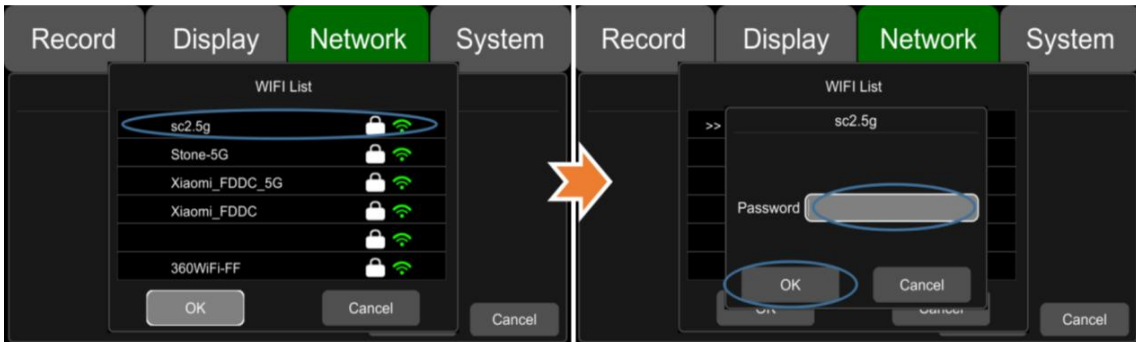

**Step 5:** Touch OK to exit.

**Step 6:** Go to "Network -> Server" page to input Wi-Fi Server IP and Port. Touch OK to save the settings.

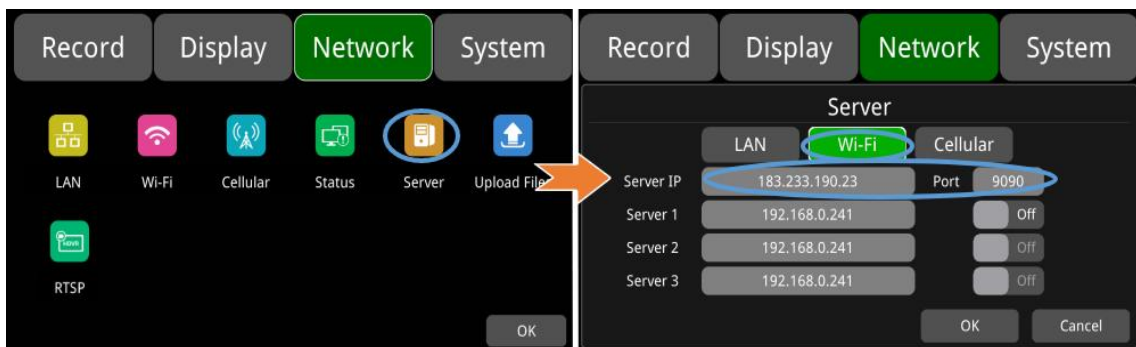

**Step 7:** Wi-Fi network status and server status can be checked on "Network ->Status". Wi-Fi Status shows "CONNECT SUCCESS" and the Server Status shows "Online".



## 10.3 2G/3G/4G Control and Setup

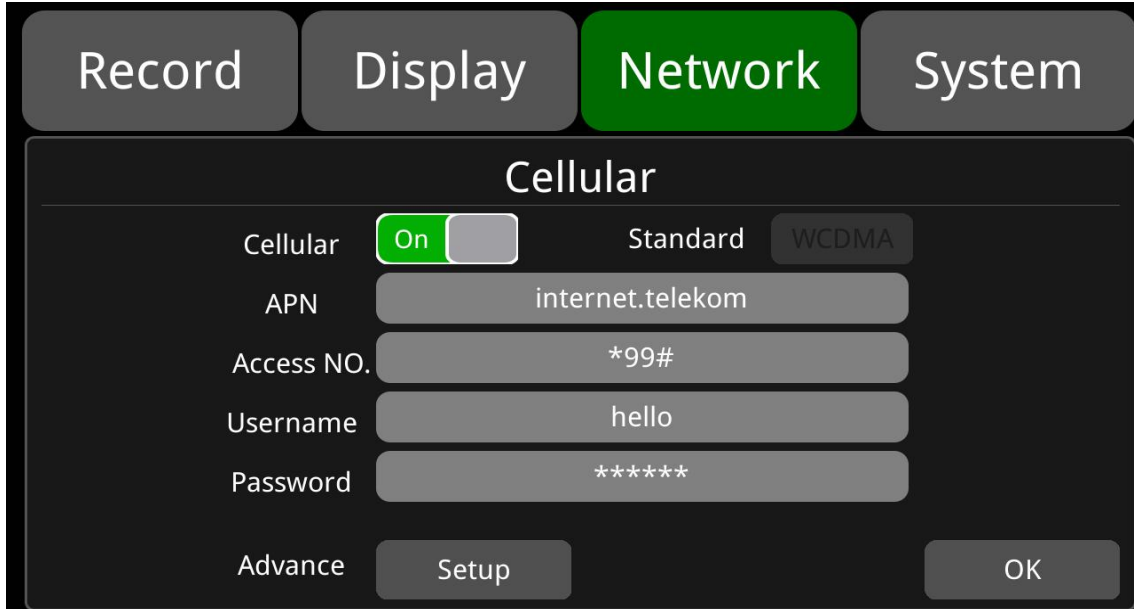

The default configuration is shown above.

**Cellular:** If Cellular is ON, it means that 2G/3G/4G is ON.

**Network Standard:** The default is WCDMA.

**APN & Access No.:** Normally, the default values for APN, Access number can be used, and the user name and password are not necessary. If the connection is not successful under the default settings, please consult your local network carrier.

**OK:** Save the settings and exit.

**Cancel:** Cancel the settings and exit.

- **2G/3G/4G Connection**

**Step 1:** DVR can search 2G/3G/4G signals locally.

**Step 2:** Connect the 2G/3G/4G antenna to connector ①&② of the rear panel of the device.



**Step 3:** Open the front panel of the device and insert the SIM card.

**Step 4:** Go to Cellular setup interface and set Cellular to “On”.



**Step 5:** Enter the correct APN and Access number. The latter is optional.

**Step 6:** Touch OK to save the settings and exit.

**Step 7:** Input the 2G/3G/4G Server IP and Port on “Network->Server”.

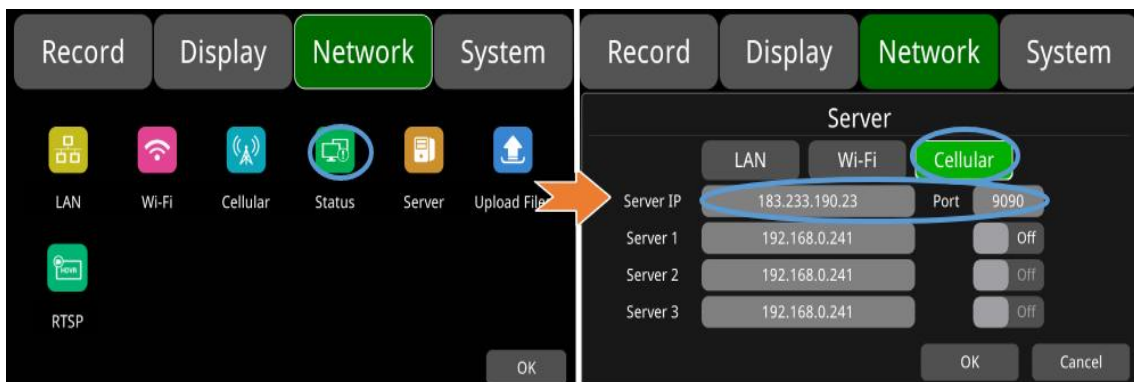

**Step 8:** Cellular network status and server status can be checked on “Network ->Status”. Wi-Fi Status shows “CONNECT SUCCESS” and the Server Status shows “Online”.

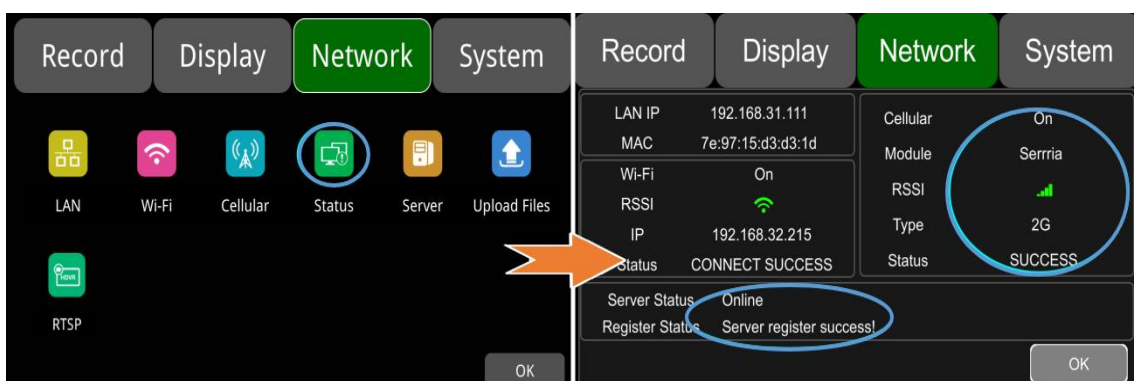

## 10.4 AP Internet Setup

- Steps to Connect AP Internet

**Step 1:** Connect the DVR to the internet through Wi-Fi or 2G/3G/4G. Please refer to Chapter 10.2 and 10.3 for connection.

**Step 2:** Set the “AP Internet” to “On”.

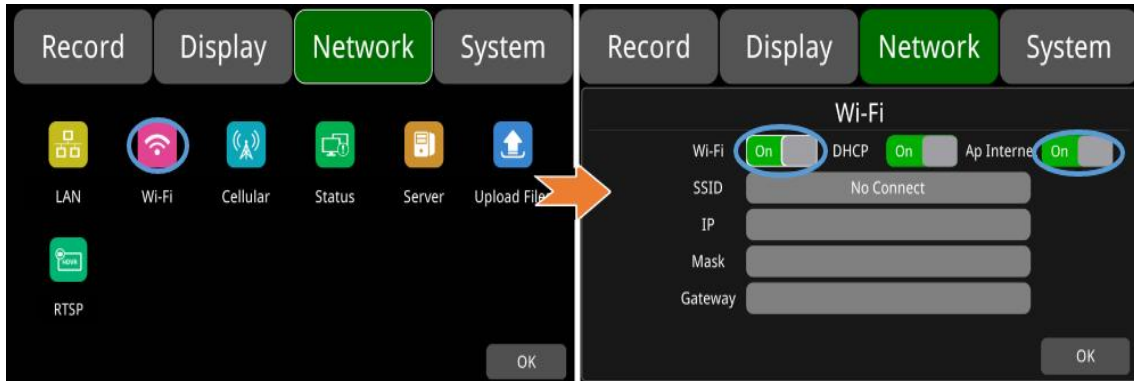

**Step 3:** Search and connect to the Wi-Fi hotspot of the DVR with other mobile devices. The SSID name of the hotspot is prefixed with “WFD-” and followed by the serial number of the device. The default password of the hotspot is ap12345678.

## 10.5 Network Status



Network Status: LAN IP address, MAC address, Wi-Fi network status, Wi-Fi IP address, Wi-Fi signal strength, cellular network status, cellular signal strength and server status, etc. can be checked. In addition, the user can verify that the network connection is successful.

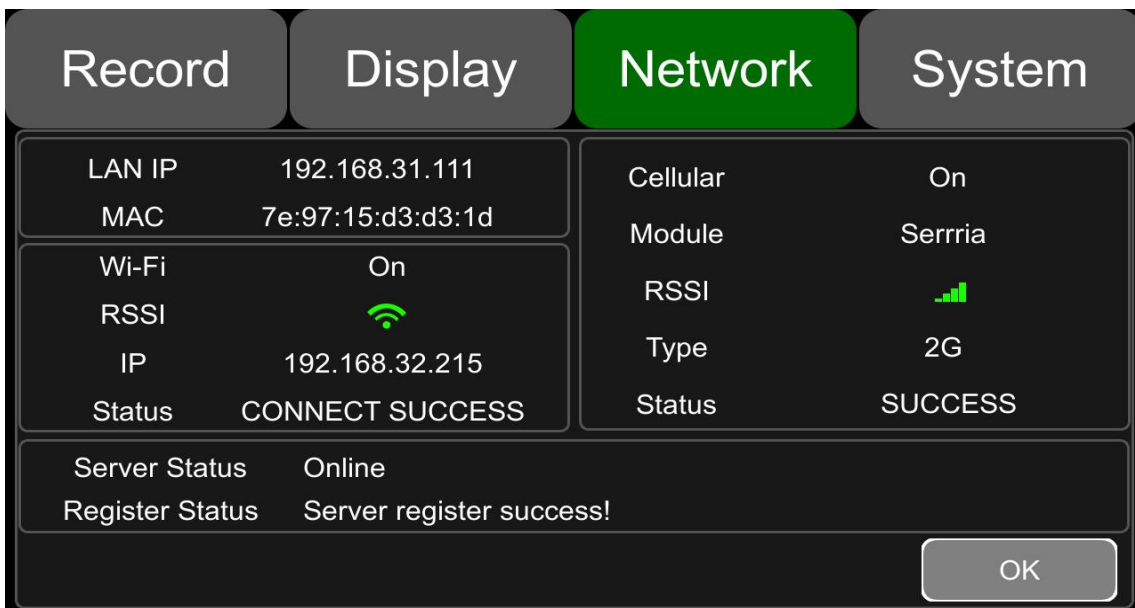

**LAN IP:** The static IP set on “Network->LAN” page or the dynamic IP obtained automatically.

**MAC:** The static physical address set on “Network-LAN” page or the dynamic physical address obtained automatically.

**Wi-Fi:** Status indication.

**Wi-Fi RSSI:** Wi-Fi signal strength indication.

**Wi-Fi IP:** Static IP obtained from “Network-Wi-Fi” page or dynamic IP address obtained automatically.

**Wi-Fi status:** CONNECT SUCCESS or GET IP ERROR.

**Cellular:** Status indication.

**Module:** The Cellular module brand.

**Cellular RSSI:** 2G/3G/4G signal strength indication.

**Cellular Type:** 2G, 3G or 4G, indicating the actual signal received.

**Cellular Status:** Please refer to the descriptions and indications below.

| Description           | Indication                            |
|-----------------------|---------------------------------------|
| Module initialization | The cellular module is initializing.  |
| Module exception      | The cellular module is in exception.  |
| No SIM card           | No SIM card is found in the DVR.      |
| Cpin locked           | Cpin is locked.                       |
| Signal abnormal       | The signal is abnormal.               |
| Networking failure    | The network connection fails.         |
| SUCCESS               | The network connection is successful. |

**Server Status:** Online / Offline.

**Register status:** Reasons for failed server connection.

## 10.6 Server



The function of the server setting is mentioned in Chapters 10.1, 10.2 and 10.3. The default server IP of LAN, Wi-Fi and Cellular are “183.233.190.23”, and the default port number is “9090”.



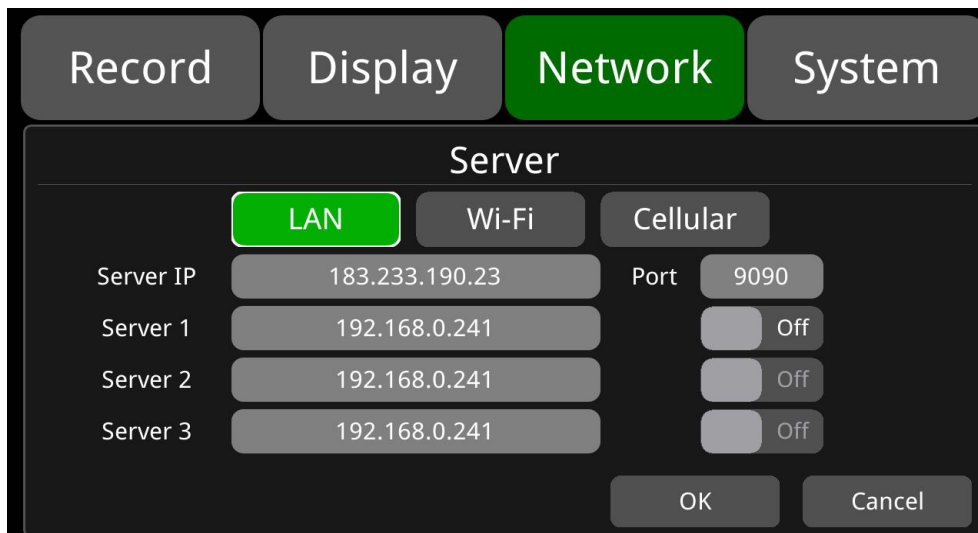

## 10.7 File Upload

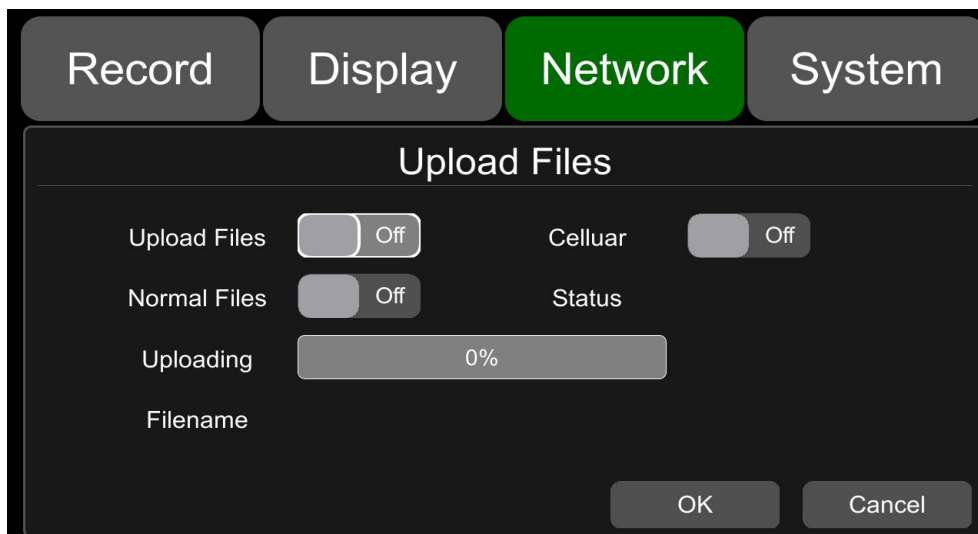

The default configuration of “Upload Files” is shown above.

**Upload Files:** “On”/“Off”. When set to “On”, the alarm video file will be uploaded to the server as long as the alarm video recording is triggered. When set to OFF, the alarm video file will not be uploaded to the server, though the recording can still be activated.

**Normal File:** Two states, “Off”/“On”.

- Off: Do not upload normal video files.
- On: Upload normal video files.

**Cellular:** Two states, “Off”/“On”. When it is set to “On”, the alarm recording file will be uploaded to the server as long as the alarm video recording is triggered and 2G/3G/4G is online.

- **Off:** Normal video files are not allowed to be uploaded when connecting to the server with Cellular. For example, the setting in the figure below means that normal video files will only be uploaded when connecting to the server with LAN or Wi-Fi instead of Cellular.

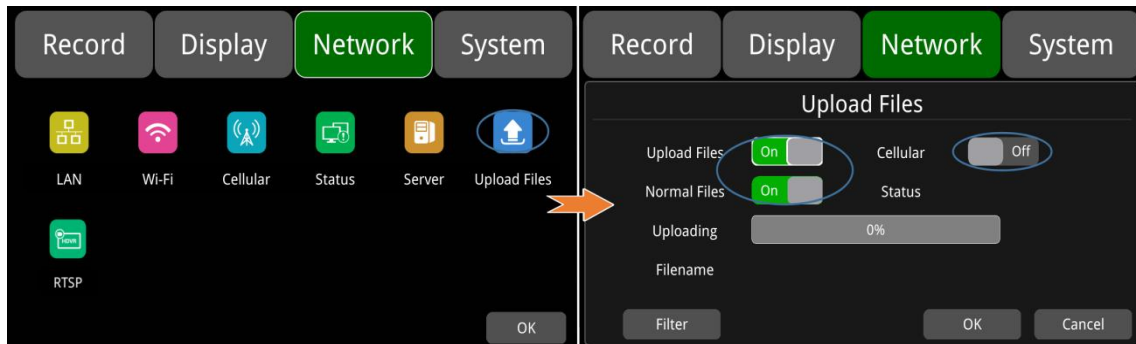

- **On:** File uploads are allowed when connecting to the server with Cellular. When the switch is turned on, a pop-up box will prompt "Network flow consuming, continue?" Click "OK" to confirm the opening. However, after this feature is turned on, once the server is connected with Cellular, video files will be uploaded, causing a lot of cellular flow consuming. So in order to save cellular flow, please set to "OFF".

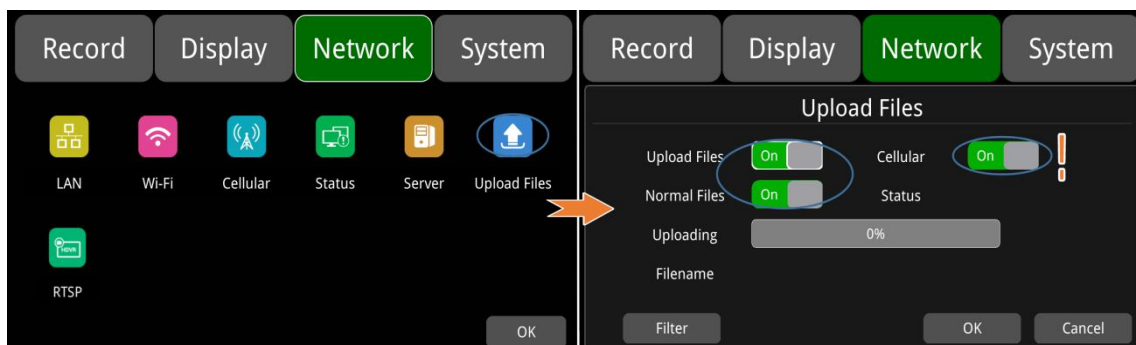

**Uploading:** Show the progress bar of the uploading video file.

**Filename:** Display the file name of the uploaded video file.

**Status:** Display the working status of Upload Files. Successfully uploaded video files can be found in the client interface below.

The screenshot shows the CMS Client interface with a table of uploaded video files. The table has the following columns: Plate No, Begin Time, End Time, Status, Percent, Download..., File Size..., File Type, File Name, and File Posit... The table contains multiple rows of data, including file names like 'snap cam...' and 'gsensor'.

| Plate No     | Begin Time   | End Time     | Status       | Percent | Download... | File Size... | File Type   | File Name                | File Posit... |
|--------------|--------------|--------------|--------------|---------|-------------|--------------|-------------|--------------------------|---------------|
| cz-426-00... | 2020-11-0... | 2020-11-0... | Not Downl... | 0%      | 0           |              | snap cam... | 20201101180942_*.03.jpg  | Media Ser...  |
| cz-426-00... | 2020-11-0... | 2020-11-0... | Not Downl... | 0%      | 0           |              | snap cam... | 20201101180942_*.01.jpg  | Media Ser...  |
| cz-426-00... | 2020-11-0... | 2020-11-0... | Not Downl... | 0%      | 0           |              | snap cam... | 20201101180942_*.04.jpg  | Media Ser...  |
| cz-426-00... | 2020-11-0... | 2020-11-0... | Not Downl... | 0%      | 0           |              | snap cam... | 20201101180942_*.02.jpg  | Media Ser...  |
| cz-426-00... | 2020-11-0... | 2020-11-0... | Not Downl... | 0%      | 3           |              | gsensor     | 20201102084315_*.03.m... | Media Ser...  |
| cz-426-00... | 2020-11-0... | 2020-11-0... | Not Downl... | 0%      | 3           |              | gsensor     | 20201102084315_*.04.m... | Media Ser...  |
| cz-426-00... | 2020-11-0... | 2020-11-0... | Not Downl... | 0%      | 3           |              | gsensor     | 20201102084315_*.02.m... | Media Ser...  |
| cz-426-00... | 2020-11-0... | 2020-11-0... | Not Downl... | 0%      | 3           |              | gsensor     | 20201102084402_*.02.m... | Media Ser...  |
| cz-426-00... | 2020-11-0... | 2020-11-0... | Not Downl... | 0%      | 3           |              | gsensor     | 20201102084402_*.04.m... | Media Ser...  |
| cz-426-00... | 2020-11-0... | 2020-11-0... | Not Downl... | 0%      | 3           |              | gsensor     | 20201102084402_*.03.m... | Media Ser...  |
| cz-426-00... | 2020-11-0... | 2020-11-0... | Not Downl... | 0%      | 3           |              | gsensor     | 20201102132958_*.04.m... | Media Ser...  |
| cz-426-00... | 2020-11-0... | 2020-11-0... | Not Downl... | 0%      | 3           |              | gsensor     | 20201102132958_*.03.m... | Media Ser...  |
| cz-426-00... | 2020-11-0... | 2020-11-0... | Not Downl... | 0%      | 3           |              | gsensor     | 20201102132958_*.02.m... | Media Ser...  |
| cz-426-00... | 2020-11-0... | 2020-11-0... | Not Downl... | 0%      | 3           |              | gsensor     | 20201102133833_*.04.m... | Media Ser...  |
| cz-426-00... | 2020-11-0... | 2020-11-0... | Not Downl... | 0%      | 3           |              | gsensor     | 20201102133833_*.02.m... | Media Ser...  |
| cz-426-00... | 2020-11-0... | 2020-11-0... | Not Downl... | 0%      | 3           |              | gsensor     | 20201102133833_*.03.m... | Media Ser...  |

**Filter:** Alarm video type and upload channel selection. The default configuration is as follows.

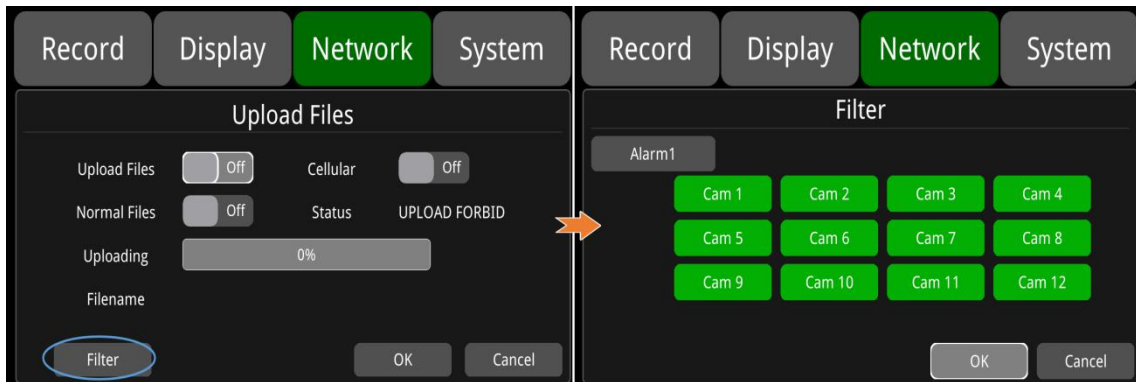

Click the Alarm1 button to select different alarm types, as shown below.

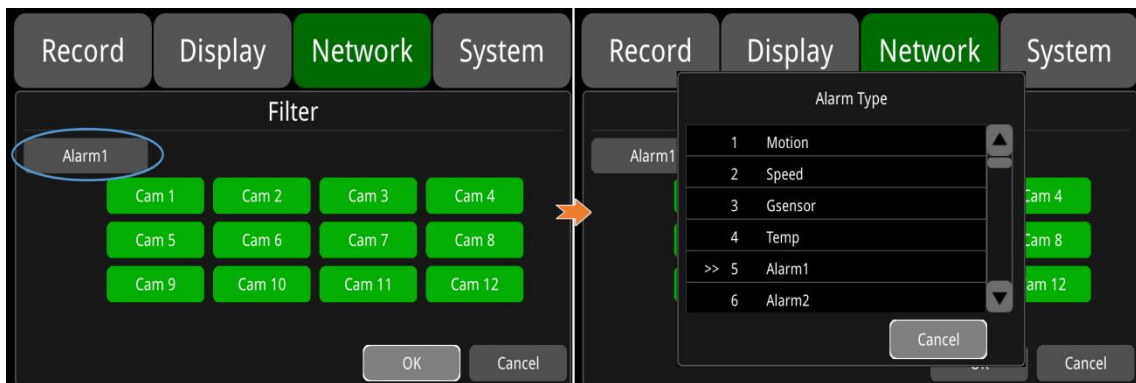

Alarm filter types:

|         |                              |        |  |
|---------|------------------------------|--------|--|
| Motion  | Motion detection alarm       | Speed  | Overspeed alarm (velocity source: GPS) |
| Gsensor | G-Sensor alarm (simple mode) | Temp   | Temperature alarm                      |
| Alarm1  | Alarm 1 alarm                | Alarm2 | Alarm 2 alarm                          |
| Alarm3  | Alarm 3 alarm                | Alarm4 | Alarm 4 alarm                          |
| Alarm5  | Reverse alarm                | Alarm6 | Brake alarm                            |
| Alarm7  | Alarm 7 alarm                | Alarm8 | Alarm 8 alarm                          |
| Button  | Panic button alarm           | Rfid   | Rfid abnormality alarm                 |
| AccLe   | Acceleration alarm           | DeceLe | Deceleration alarm                     |

|               |  |               |                                      |
|---------------|--|---------------|--------------------------------------|
| AccTurn       | Turning acceleration alarm                 | GyrTurn       | Turning angular velocity alarm       |
| Impact        | Collision alarm                            | GyrTurnLeft   | Left turn alarm                      |
| GyrTurnRight  | Right turn alarm                           | GyrClipFile   | Active clip alarm                    |
| Button1       | Panic button 1 alarm                       | Button2       | Panic button 2 alarm                 |
| Button3       | Panic button 3 alarm                       | Button4       | Panic button 4 alarm                 |
| Button5       | Panic button 5 alarm                       | Button6       | Panic button 6 alarm                 |
| Button7       | Panic button 7 alarm                       | Button8       | Panic button 8 alarm                 |
| Fatigue       | Fatigue alarm                              | Distraction   | Distraction alarm                    |
| NoDriver      | No driver alarm                            | Smoking       | Smoking alarm                        |
| Calling       | Calling alarm                              | PasserBy      | Pedestrian detection warning         |
| Crash         | Forward collision warning                  | Skewing       | Lane departure warning               |
| OverSpeed     | Overspeed alarm<br>(velocity source: ADAS) | Snapacm       | Screenshot alarm                     |
| Radar         | Radar alarm                                | Rfid ERR      | Abnormal swiping alarm               |
| Rfid Sameid   | Abnormal card number alarm                 | Rfid Sum      | Inconsistent passenger number alarm  |
| Rm mem        | Card off alarm                             | Yawn          | Yawn alarm                           |
| FaceFail      | Face recognition failure alarm             | No Mask       | No mask alarm                        |
| Fatigue2      | Second-time fatigue alarm                  | Over Temp     | High temperature alarm               |
| Less Temp     | Low temperature alarm                      | OverReco Temp | High temperature recovery alarm      |
| LessReco Temp | Low temperature recovery alarm             | OpenDoor      | Door opening alarm                   |
| CloseDoor     | Door closing alarm                         | SABOTAGE      | Sabotage alarm                       |
| BsdPasserby 1 | Pedestrian detection alarm channel 1       | BsdPasserby2  | Pedestrian detection alarm channel 2 |
| BsdPasserby 3 | Pedestrian detection alarm channel 3       | BsdPasserby4  | Pedestrian detection alarm channel 4 |

## 10.8 RTSP Streaming

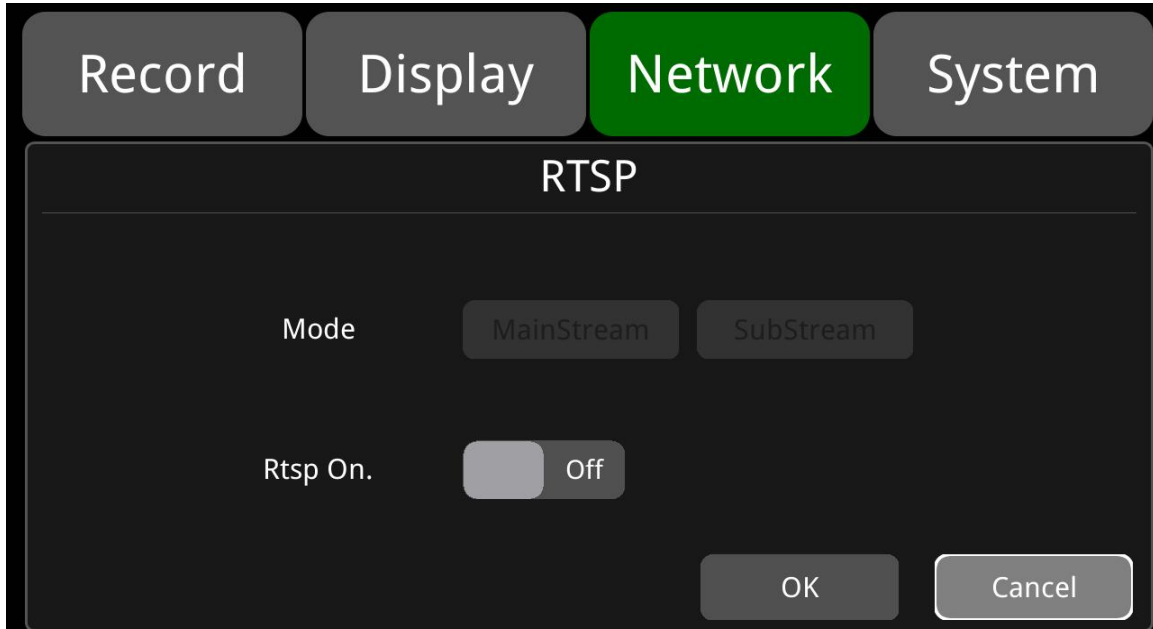

The default configuration is shown above.

- **RTSP On:** Set RTSP to “On”/“Off”.
- **Mode:** Set MainStream & SubStream to “On”/“Off”.

Mode on/off Instructions: When set RTSP to “On”, make sure the streaming device and DVR are under the same local area network such as simply using DVR’s own hotspot AP, then images can be displayed. Or just connect the DVR and the device to the same route (Note: 192.168.100.140 is the fixed IP address of DVR’s AP hotspot).

Open the network stream of the pull-streaming device, and enter the streaming address as the network URL. A total of 8 push-streams including 4 main-streams and 4 sub-streams. The formats of URL are as follows:

main-stream: rtsp://Ip Address/cam1/mainstream.

sub-stream: rtsp://Ip Addr/cam1/substream.

Once connected successfully, corresponding images will be played.

# 11 System

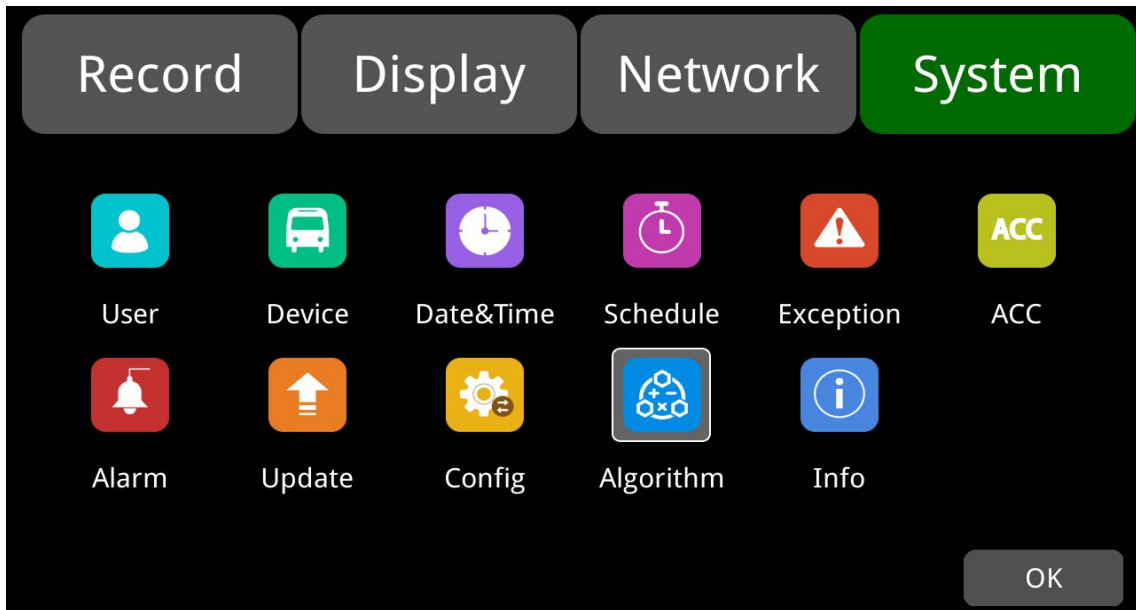

## 11.1 Log in Setup



Set user name and password for booting up. The initial password is 123.

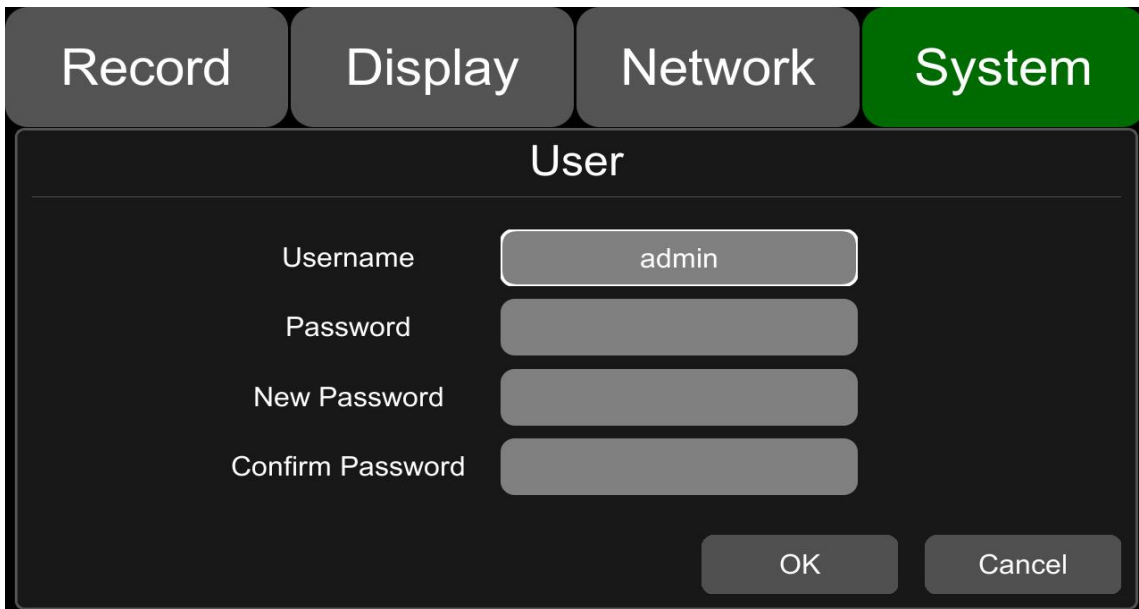

## 11.2 License Plate Number Setup



License No.: Input license plate number. The default configuration is shown below.

|               |   |         |   |
|---------------|---|---------|---|
| Record        | Display                                 | Network | <b>System</b>   |
| <b>Device</b> |   |         |   |
| License No.   | <input type="text" value="AAAAAA"/>     |         |   |
| Device ID     | <input type="text" value="1711280010"/> |         |   |
|               |   |         | <input type="button" value="OK"/> <input type="button" value="Cancel"/> |

### 11.3 System Time Setup



Format Setup: System time format setting.

|                       |   |   |   |   |
|-----------------------|---|---|---|---|
| Record                | Display                                   | Network                                   | <b>System</b>   |   |
| <b>Dates&amp;Time</b> |   |   |   |   |
| Date                  | Year<br><input type="text" value="2018"/> | Month<br><input type="text" value="06"/>  | Day<br><input type="text" value="21"/>                                  | <input type="button" value="1"/> <input type="button" value="2"/> <input type="button" value="3"/><br><input type="button" value="4"/> <input type="button" value="5"/> <input type="button" value="6"/><br><input type="button" value="7"/> <input type="button" value="8"/> <input type="button" value="9"/><br><input type="button" value="0"/> <input type="button" value="Del"/> |
| Time                  | Hour<br><input type="text" value="11"/>   | Minute<br><input type="text" value="17"/> | Second<br><input type="text" value="38"/>                               |   |
| Format                | <input type="button" value="Setup"/>      | Time Sync                                 | <input type="button" value="Setup"/>                                    |   |
| DST                   | <input type="button" value="Setup"/>      |   |   |   |
|                       |   |   | <input type="button" value="OK"/> <input type="button" value="Cancel"/> |   |

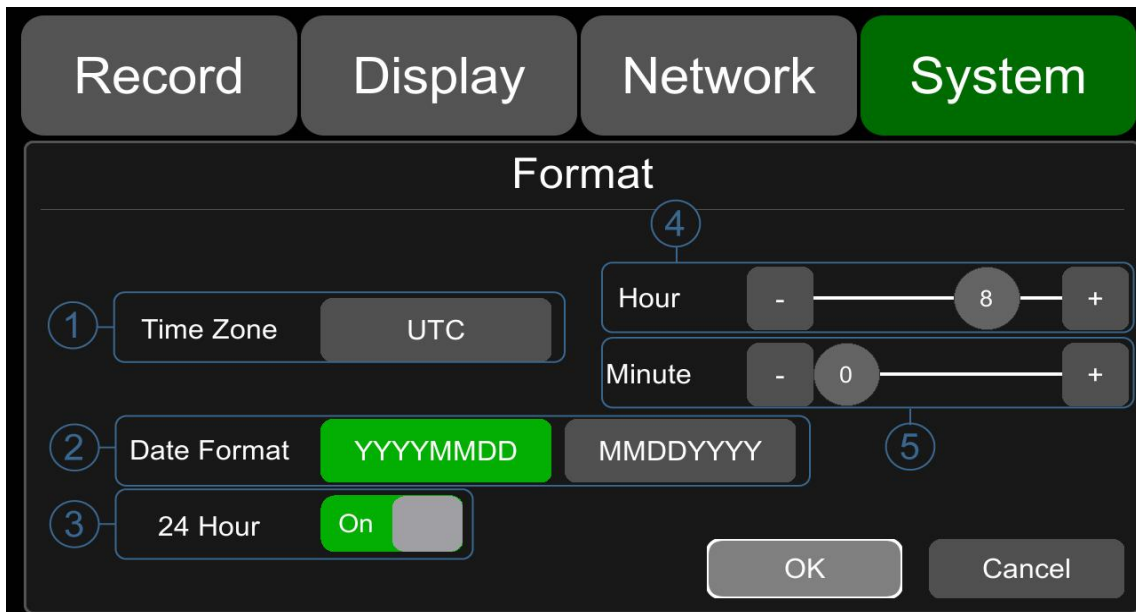

Default "Format" configuration is shown above.

Go to "System – >Date &Time - >Format->Setup" page.

- ① **Time Zone:** Time zone setting.
- ② **Date Format:** Date format setting
- ③ **24 Hour:** If it is ON, time format will be displayed in the 24-hour system. If OFF, it will be displayed in the 12-hour system.
- ④&⑤ **Hour & Minute:** Time zone settings are accurate to the minute.

| ● Hour & Minute | ● Min. | ● Max. | ● Default |
|-----------------|--------|--------|-----------|
| ● Hour          | ● -12  | ● 14   | ● 8       |
| ● Minute        | ● 0    | ● 59   | ● 0       |

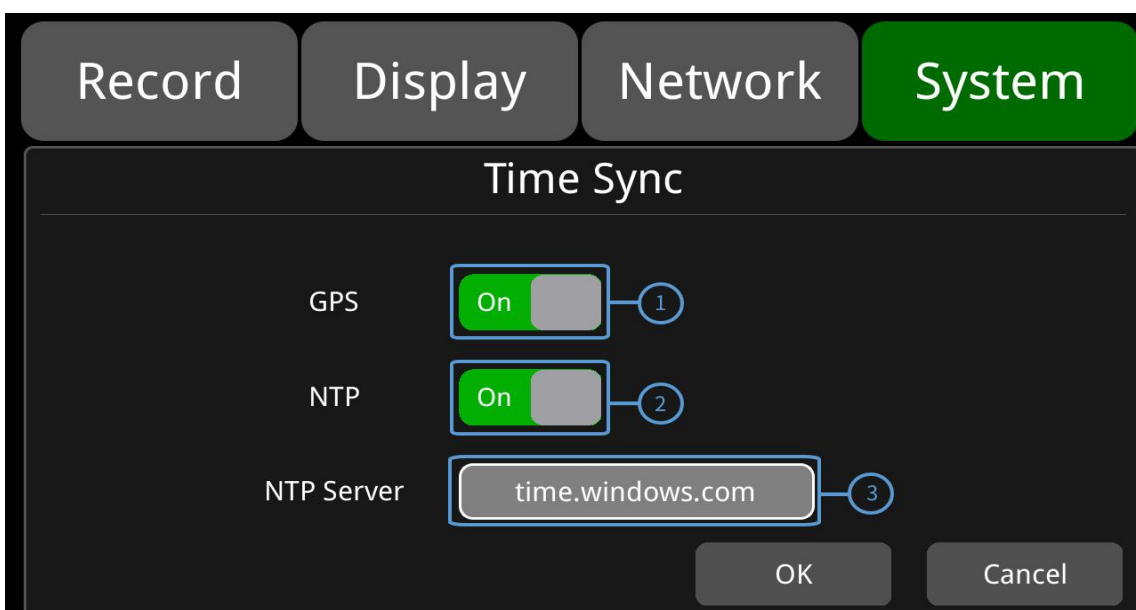



Default "Time Sync" configuration is shown above.

### Time Ssync Setup:

Go to "System -> Date &Time ->Time Sync->Setup" page.

- ① **GPS:** Set GPS to "On"/"Off".
- ② **NTP:** Set NTP to "On"/"Off".
- ③ **NTP Server:** Show the URL of the NTP Server.

| Application scene   | Usage   |
|---------------------|---|
| GPS: Off & NTP: Off | Set the time zone and daylight saving time first, then set the date and time.     |
| GPS: On / NTP: On   | Time zone and daylight saving time must be set, and no need to set date and time. |

Note: When "Time Sync"->"GPS" or "Time Sync"->"NTP" is On, the time zone and daylight saving time must be set; if the time zone is not set, GPS and NTP will automatically adjust the system time to the default East 8 time zone, resulting in abnormal device time.

### DST Setup:

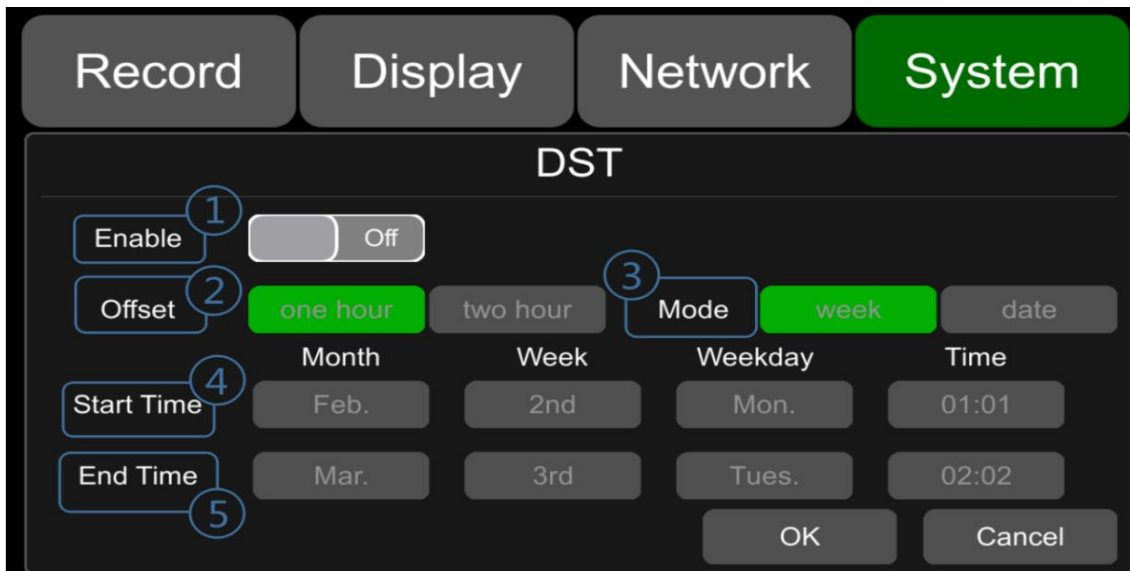

Default "DST" configuration is shown above.

Go to "System -> Date &Time -> DST-Setup" page.

- ① **Enable:** Set DST to "On"/"Off".
- ② **Offset:** Adjust the offset to one or two hours after enabling DST.

- ③ **Mode:** Select the mode of DST (set DST according to week or date).
- ④ **Start:** Set the start time of DST.
- ⑤ **End:** Set the end time of DST.

## 11.4 Scheduled Recording



| Record          | Display                      | Network | System |         |
|-----------------|------------------------------|---------|--------|---------|
| <b>Schedule</b> |                              |         |        |         |
|                 | Enable                       | Start   | End    | Weekday |
| Schedule 1      | <input type="checkbox"/> Off | 00:00   | 01:40  | Setup   |
| Schedule 2      | <input type="checkbox"/> Off | 00:00   | 01:40  | Setup   |
| Schedule 3      | <input type="checkbox"/> Off | 00:00   | 01:40  | Setup   |
| Schedule 4      | <input type="checkbox"/> Off | 00:00   | 01:40  | Setup   |
|                 |                              | OK      | Cancel |         |

The default configuration is shown above.

**Enable:** Set scheduled recording to “On”/“OFF”.

**Start:** Set the start time of scheduled recording.

**End:** Set the end time of scheduled recording.

**Weekday:** Set up scheduled recordings by weekday. Select the weekday to preset.

**Scheduled Recording:**

- Support up to four appointed tasks. The recording duration is counted in minutes.
- Recording time can overlap.
- The start time of the scheduled recording must be set ahead of the end time.

## 11.5 Exception



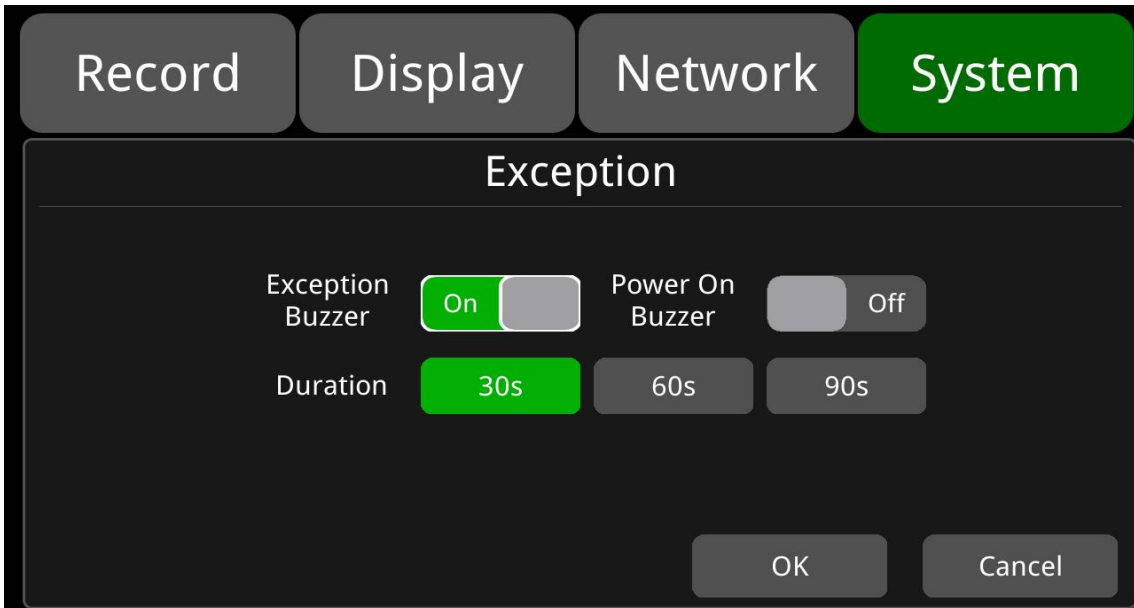

The default configuration is shown above.

**Exception Buzzer:** Exception Buzzer can be set to “On”/“Off”.

**Power On Buzzer:** Power On Buzzer can be set to “On”/“Off”.

**Duration:** Set the duration of the buzzer.

## 11.6 ACC Settings

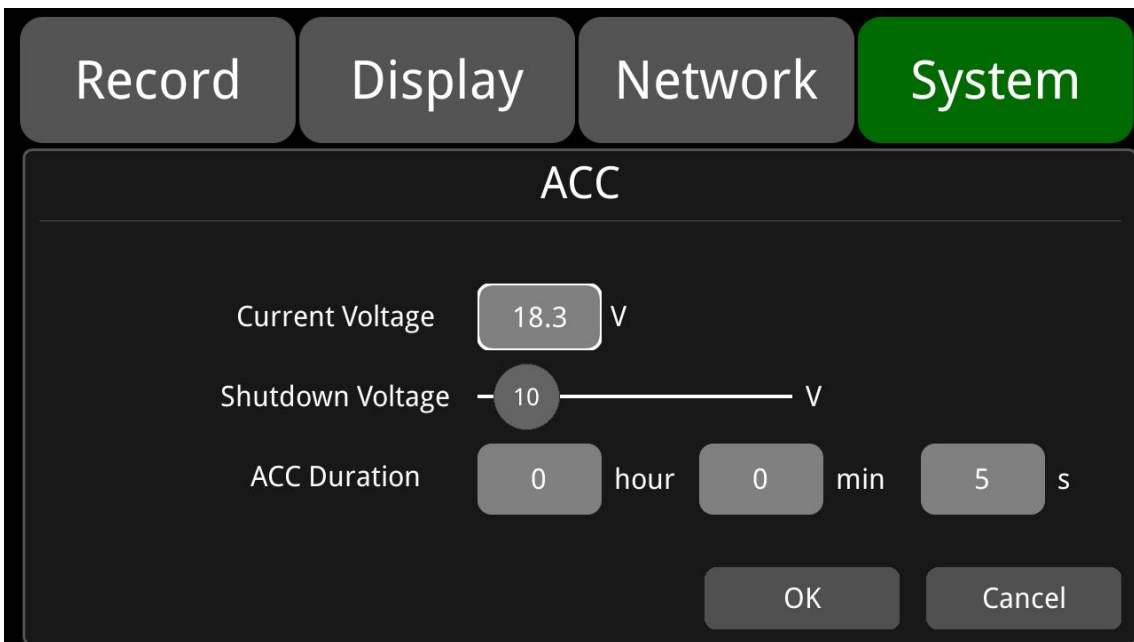

The default configuration of "Shutdown Voltage" and "ACC Duration" is shown above.

**Current voltage:** Voltage of the working DVR.

**Shutdown voltage:** The DVR automatically shuts down when the voltage of the current is lower than the Shutdown voltage and works properly or restarts only when the voltage is higher than the Shutdown voltage. When the current or voltage is lower than shutdown voltage and the device is shut down, users could disconnect the VCC of the device for one minute, then the device will come back to work for one minute. During this time, users can change the value of shutdown voltage.

**ACC Duration:** The device will continue recording for a few seconds after ACC is disconnected. ACC duration can be set to 5s~72h.

| ACC              | Min. | Max. | Default |
|------------------|------|------|---------|
| Shutdown Voltage | 9V   | 24V  | 10V     |
| ACC Duration     | 5s   | 72h  | 5s      |

## 11.7 Alarm Information Setting

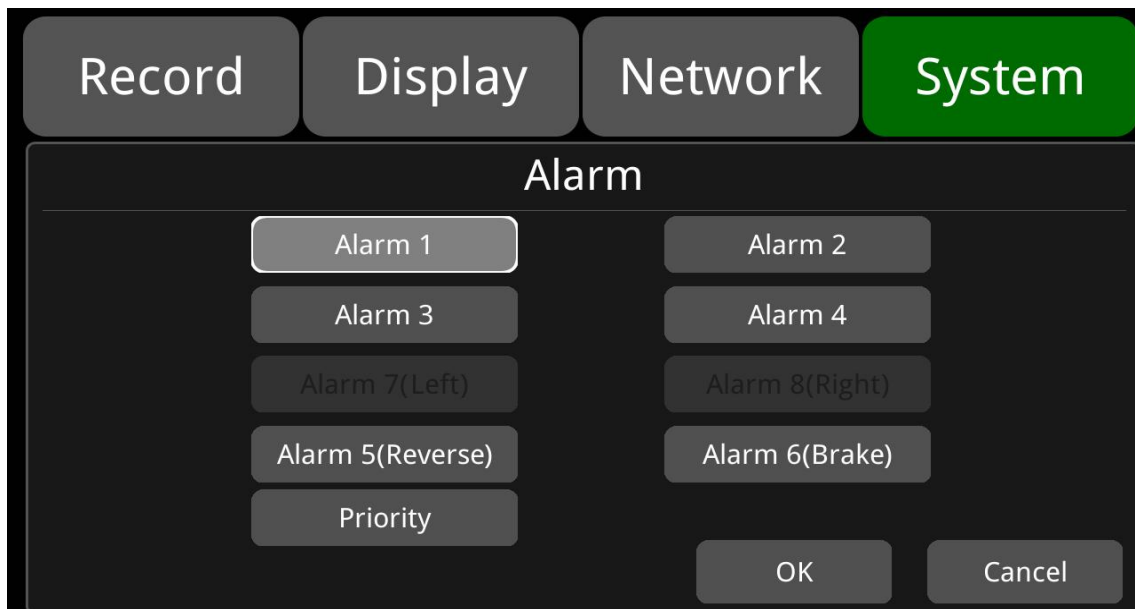

**Alarm 1~Alarm 4:** Customized alarm recording.

**Reverse:** Reversing alarm recording.

**Brake:** Brake alarm recording.

**Priority:** Set priorities for Alarm1~Alarm4, Reverse, and Brake.

When different types of alarm are triggered at the same time, alarms with the highest priority will work first.



The default "Alarm 1" configuration is shown above.

**Trigger Level:** There are 3 options of Trigger Level. The options "Low" and "High" are used for triggering alarms. "Low" is generally used for debugging while "High" will be selected to trigger alarms for on-road use. "Off" means turning off alarm trigger function.

**Output Duration:** Duration of the "Display", "Curser", and "Alarm Out" effect. Output Duration can be selected from 0sec, 5sec, 10sec, 30sec, 60sec, 5min, 10min, 30min, 60min, Always.

**Alarm Out-Buzzer:** Set to "On" or "Off" of the Alarm Out-Buzzer. The buzzer sounds for 5 seconds in alarm by default.

**Alarm Out-Output1:** If set it to "On", then 12V level output would come from the alarm wire of Output 1.

**Alarm 1 Rec.:** Alarm 1 event recording switch. The recording duration is set in [System]-> [Record]-> [Event Duration].

**Display:** When the alarm is triggered, the selected split mode will be displayed; the available split modes are shown in the figure below.

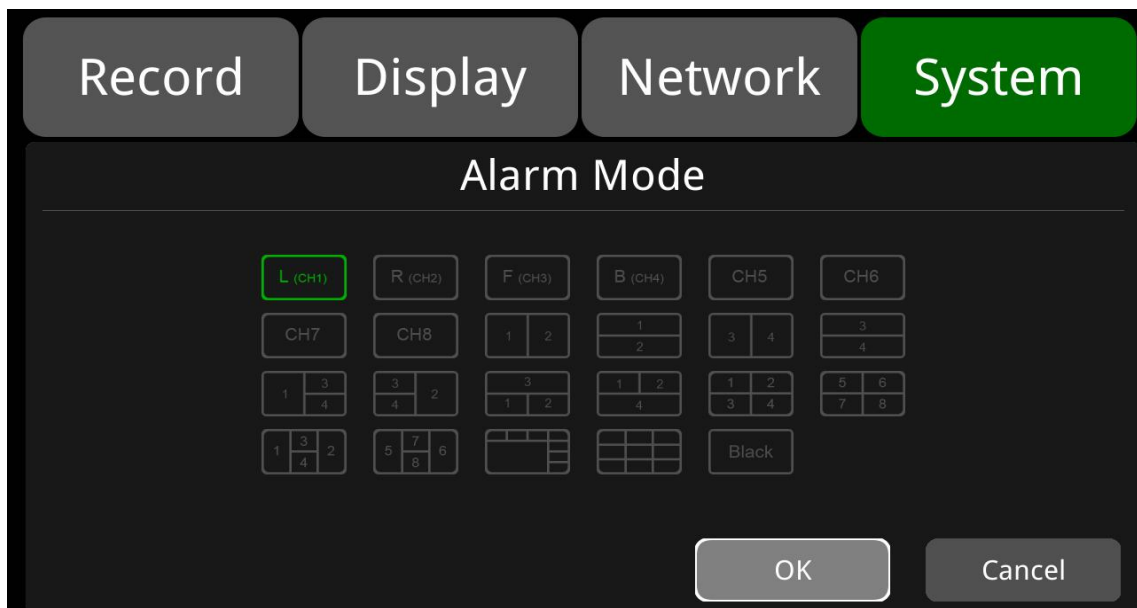

**Cursor:** It is “OFF” by default. The figure below shows the “On” state.

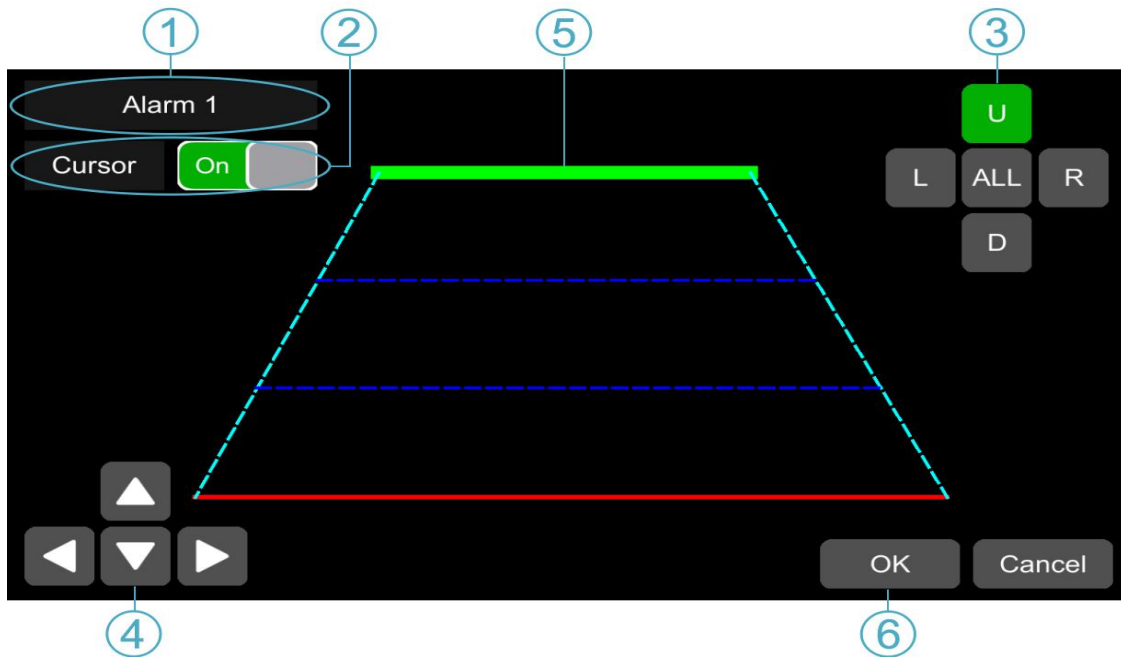

- ① Camera name of the alarm-triggered channel.
- ② Touch this button to turn on/off the corresponding cursor.
- ③ Line selecting: There are five lines to be selected. Line U (up), Line D (down), Line L (left), Line R (right) and ALL. The button turns green if selected. You can quickly operate with “1, 2, 3, 4, 5” on the remote control.
- ④ There are four directions to adjust the shape of the cursor, Up, Down, Left and Right.
  - If Line U (the green one) or Line D (the red one) is selected, the selected line can be moved as a whole with these direction buttons.
  - If Line L or Line R is selected, the top point of the selected line can be moved to left or right with Direction Down or Direction Up, and the bottom point of the selected line can be moved to left or right with Direction Left or Direction Right.If ALL is selected, all the lines can be moved as a whole in these four directions.
- ⑤ Lines of cursor. The selected one will be thickened three times. The middle two will not be processed.
  - Touch OK to save the settings and exit. Cancel to exit without saving any settings.

**Priority:** The default configuration is shown below.



: Press this button to increase the priority value of the selected alarm by 1. The bigger the value is, the lower the priority will be.



: Press this button to decrease the priority value of the selected alarm by 1. The smaller the value is, the higher the priority will be.

- Alarms with higher priority will be triggered first.
- 1 is the highest priority, and 6 is the lowest.
- If two alarms A and B are both triggered at the same time, and A's priority is higher than B's, A will record first. Once A's recording is complete, if B is still being triggered, B will then record. However, if B is no longer being triggered, it will not record.
- Suppose alarm B is triggered and is recording. When alarm A is triggered suddenly, although A has a higher priority than B, B will continue recording.

## 11.8 Update



- **For Single Device**

**Step 1:** Copy the files to the USB disk or the "/upgrade/packet/local" directory of the SD card and insert the USB disk or SD card into the DVR.

**Step 2:** Power off the DVR and reboot it, then it will upgrade automatically. Or go to Menu -> System -> Update->Software, touch OK to confirm the upgrading. Both methods can initiate an upgrade.

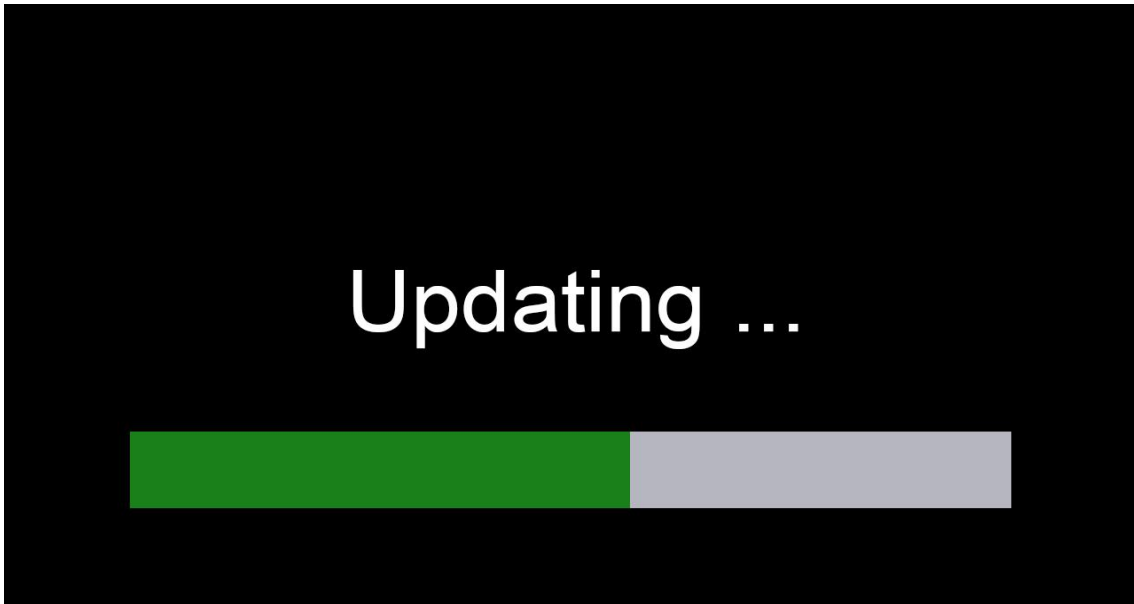
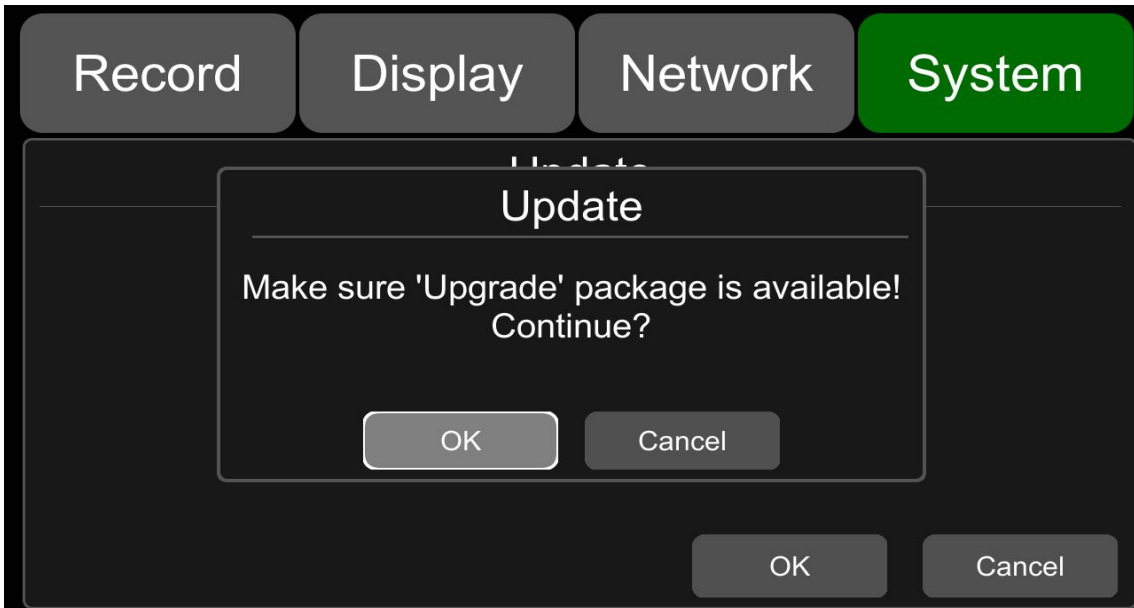

**Step 3:** When "Update success!" is shown on the display, the device will reboot automatically.

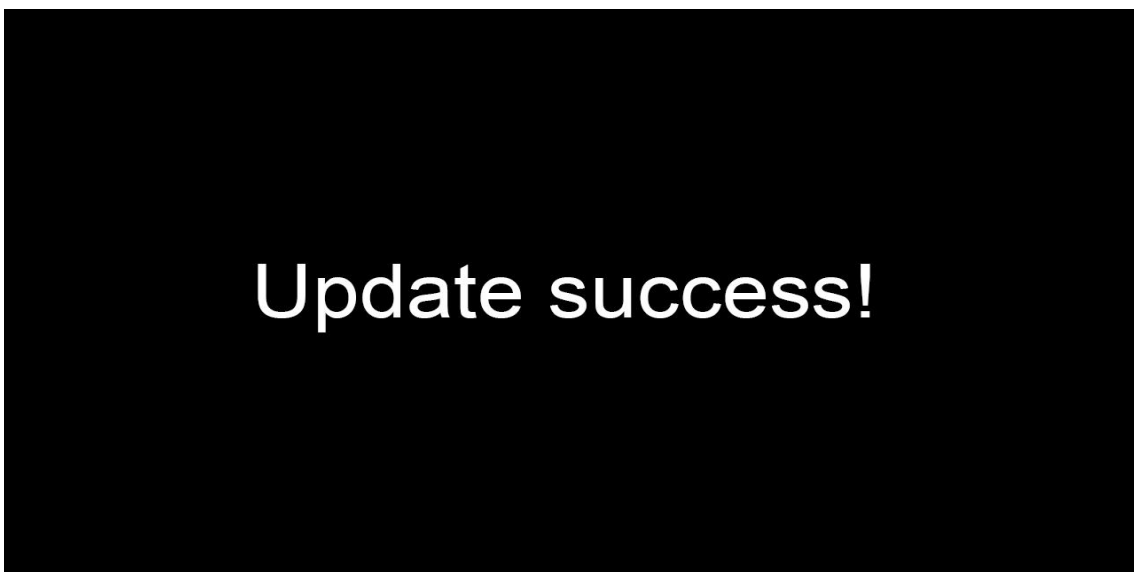



**Step 4:** After rebooting, please go to Menu -> System -> Info to check if the version is the same as the one you copy into “upgrade” folder.

**Note:** After the upgrade is complete, the "dvxxx\_upgrade\_201xxxxxxxxx\_Rename" upgrade package in the USB disk or the /upgrade/package/local directory of the SD card will be deleted.

- **Remote Upgrade**

**Step 1:** Connect the DVR to the server.

**Step 2:** Open the Windows client and log in.

**Step 3:** Find the license number of the target device in the device list of the client, right-click on it and choose “Update” to access the Batch Upgrades interface. If you need to upgrade multiple devices, you can click the Add button to select additional devices. The selected ones will be displayed on the device list for upgrading. If you want to remove devices from the list, simply select them and click the Del button.

**Step 4:** Select the device to upgrade, and then click the Browser button to select the upgrade package “dvxxx\_upgrade\_201xxxxxxxxx\_Rename”.

**Step 5:** Click the Start button to upload the upgrade package. When uploading is finished, the device will start upgrading automatically. If it fails to upload, the reason of failure will be displayed in the Remarks column in the list.

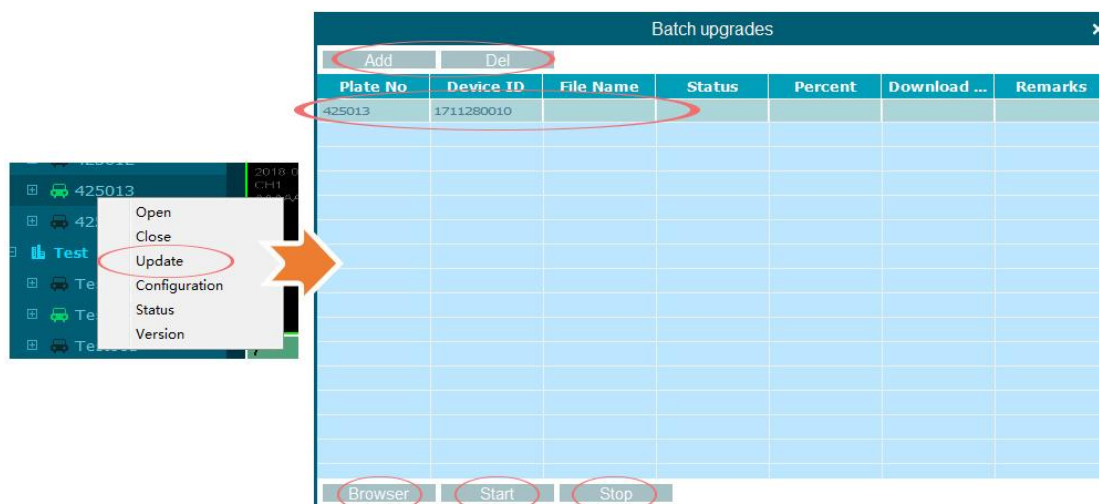

## 11.9 Configuration



**Configuration Import:** Import the configuration information from the flash memory device, and place the configuration file in the sd/export\_file/config directory.

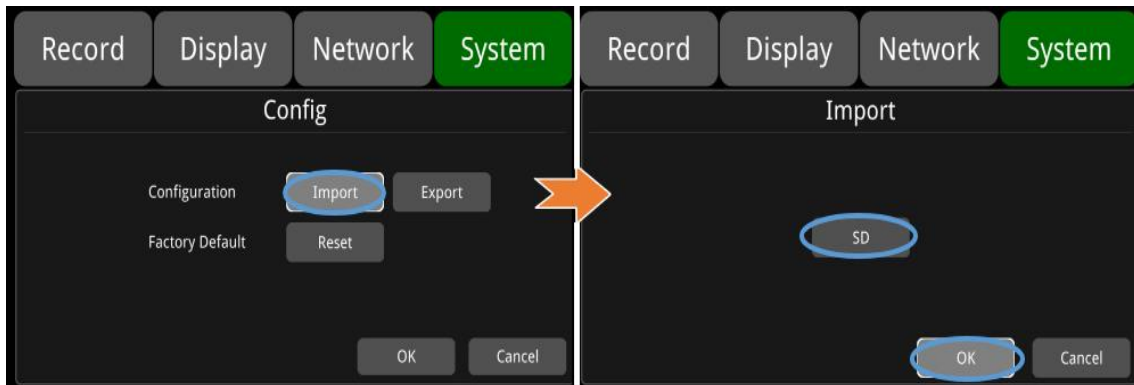

**Configuration Export:** Export Log to flash memory devices.

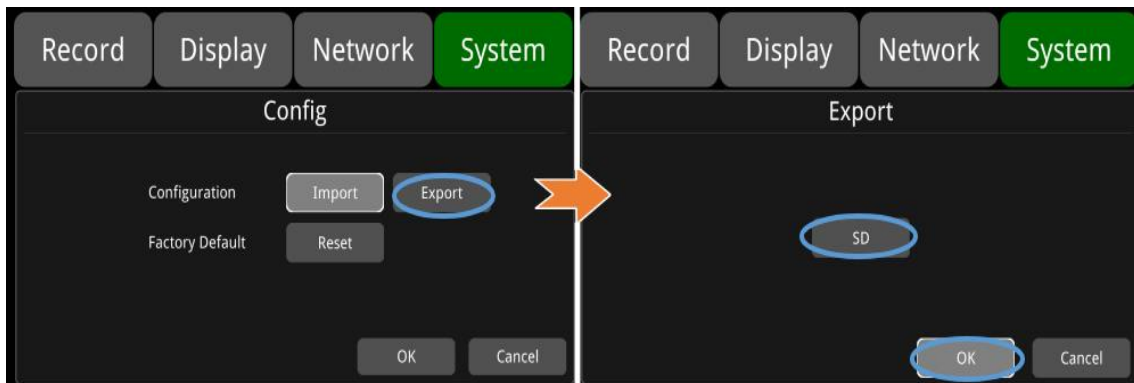

**Factory Default:** Press the Reset button to restore factory settings.

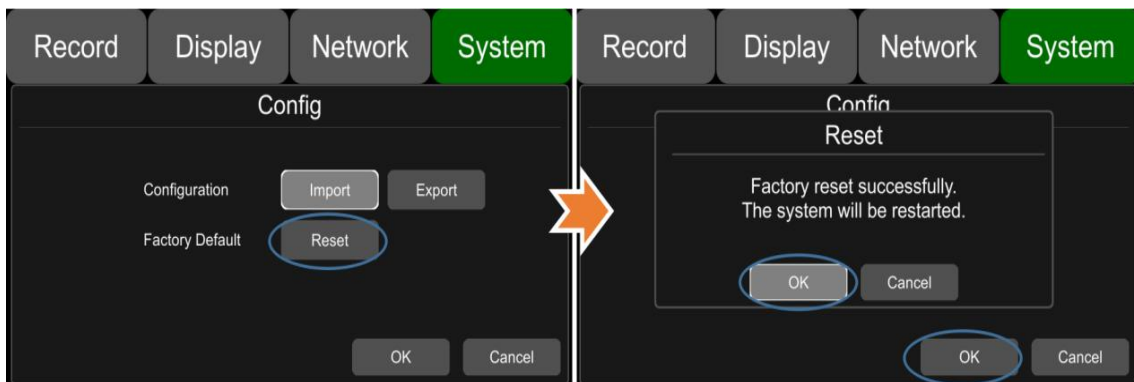

## 11.10 Application Setting



AI: Algorithm. ADAS (Advanced Driving Assistance System), DMS (Driver Monitoring System), BSD (Blind Spot Detection) and APC (Automatic Passenger Counting) algorithms can be set. By default, these 4 channels are empty. You can manually select the algorithm of the corresponding channel. After selecting, the machine will automatically restart, and you can configure the corresponding function after reboot.

In addition, one channel each can be selected for ADAS and DMS. Up to four channels can be used simultaneously for BSD, and two channels can be used simultaneously for APC. All four algorithms can be used together.

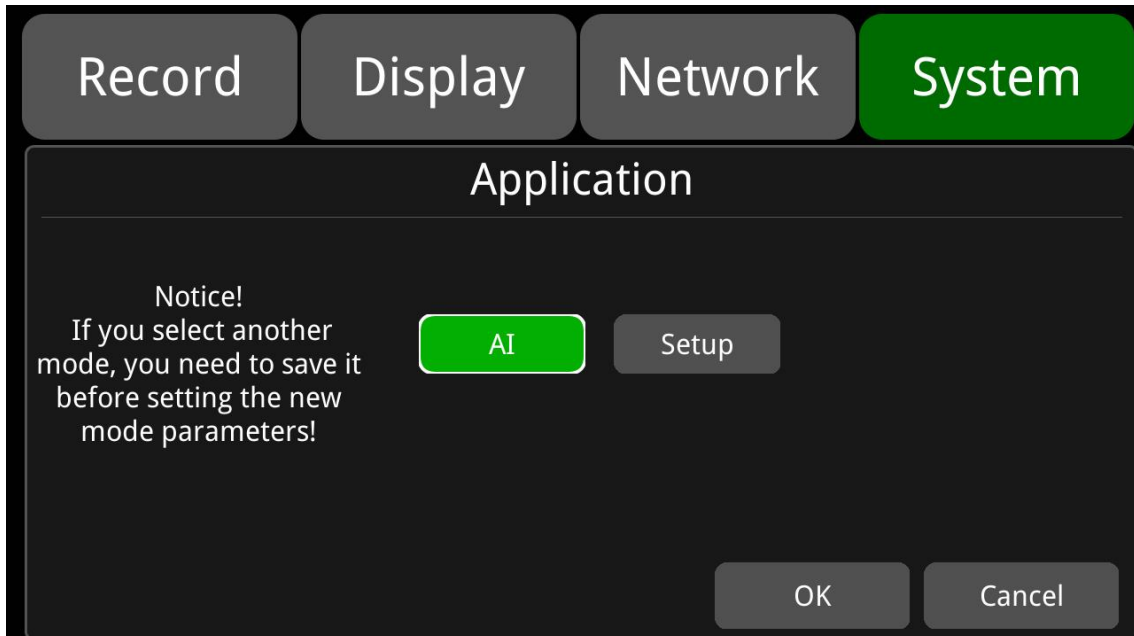

### ADAS Algorithm

FCW, i.e., forward collision warning algorithm, and PDS, i.e., pedestrian detection system are included.

The following figure shows the default configuration interface:

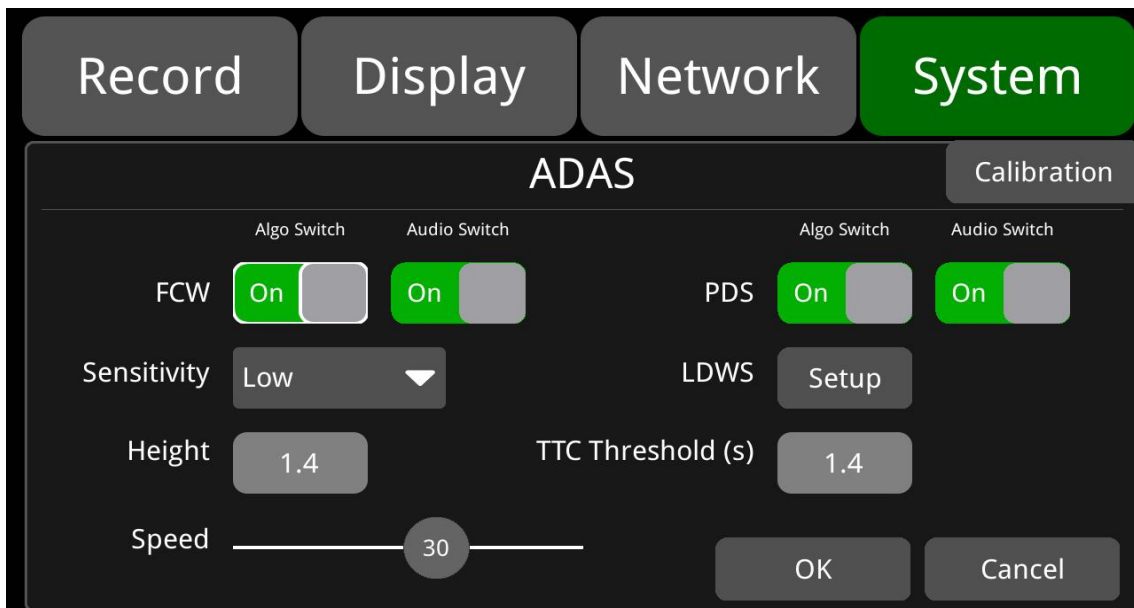

**Algo Switch:** If it is set to “On”, when the expected collision time TTC Threshold (s) is less than the configured time, the forward collision alarm and pedestrian detection alarm will be triggered. If it set to OFF, the alarm will not be triggered even if the expected collision time TTC Threshold (s) is less than the configured time.

**Audio Switch:** If it is set to “On”, audio warning will be sent when forward collision alarm and pedestrian detection alarm are triggered; if it is set to OFF, no audio warning will be activated when forward collision alarm and pedestrian detection alarm are triggered.

**TTC Threshold(s):** Time-to-collision. The default value is 1.4.

**Sensitivity:** Sensitivity level. There are three levels, Low, Medium, and High, with the default of Low.

**Speed:** Set the FCW working speed value. For example, when it is set to 5, it indicates that the FCW can only start when the vehicle speed is larger than or equal to 5km/h. The default value is 30.

**FCW installation:** Installed in front of the windshield, with a height of approximately 1.4m.

**FCW Installation Diagram:** Based on the vehicle models below, select the glass region near the red dot as the mounting location and wipe it clean with a duster. Make sure to install the camera in a horizontal position. If FCW needs to be mounted in other positions, please ensure that the windshield wiper can reach the glass that is facing the camera, so the part that camera sees through can remain clean.

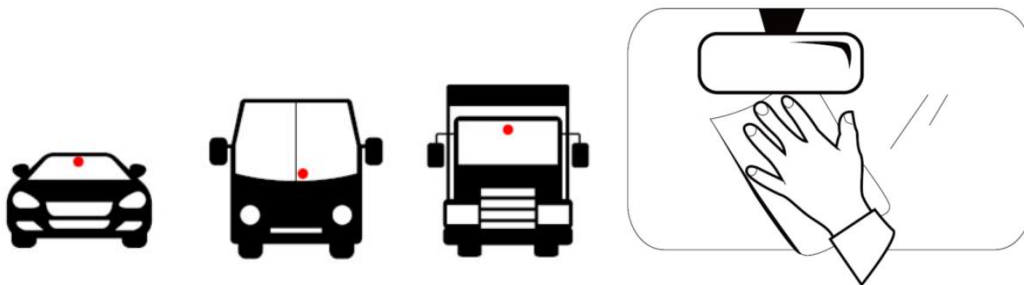

**Calibration:** Parameter calibration. Adjust the camera angle to fix the camera when the road and sky may each occupy half of the screen, as shown below:

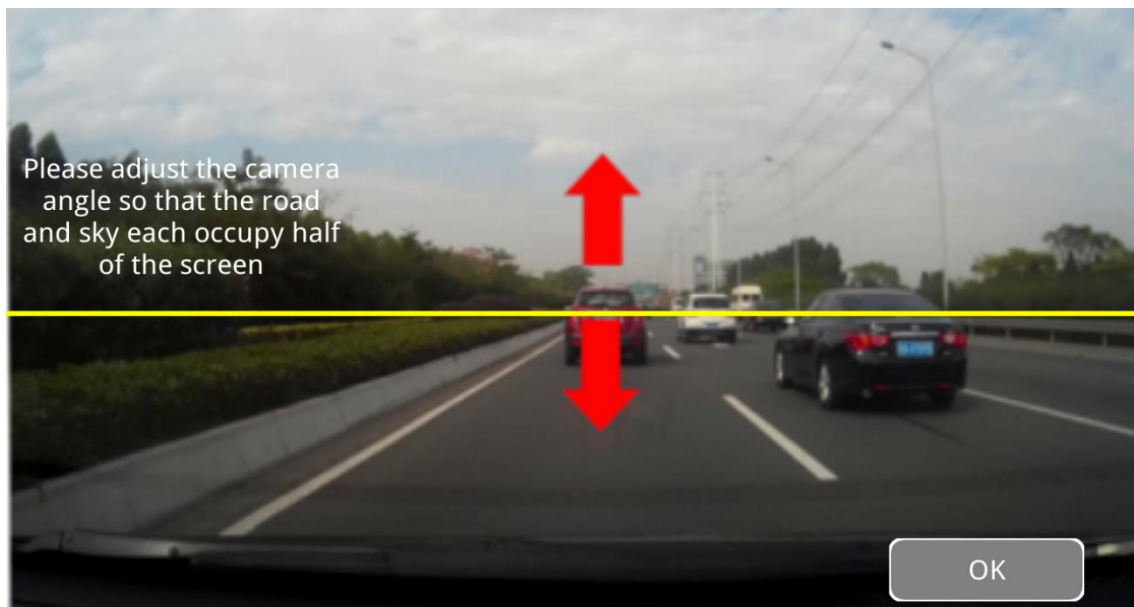

**LDWS:** Lane departure warning. In the event of a lane departure, the first channel will display the corresponding screen. The following figure shows the default configuration interface:

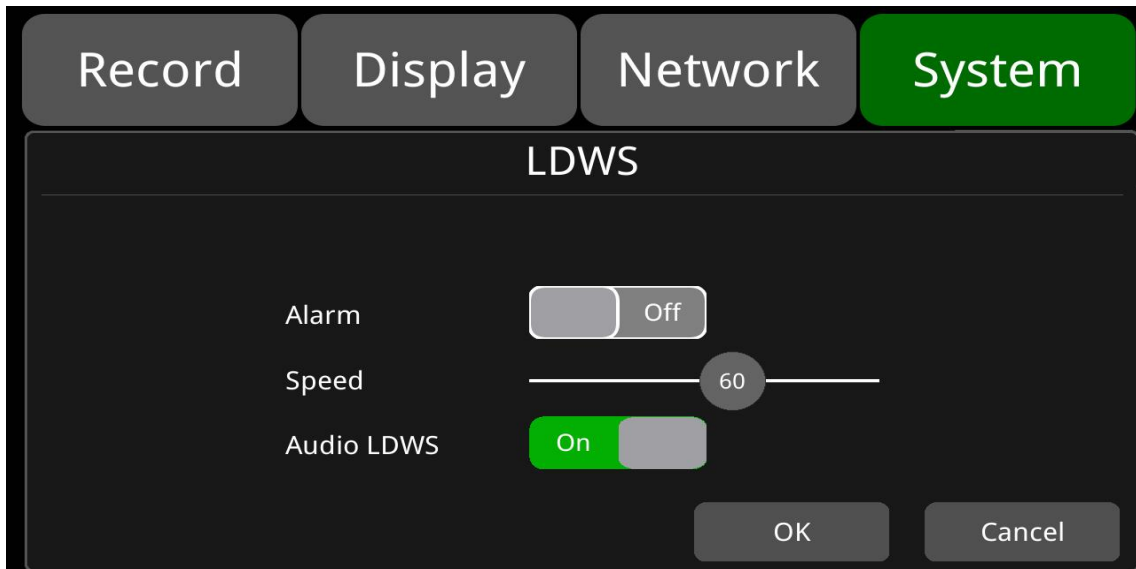

**Alarm:** If it's set to ON, when the current speed is higher than the preset working speed and the vehicle departs from the lane, then lane departure alarm recording will be triggered. When it's set to OFF, when the current speed is higher than the preset working speed and the vehicle departs from the lane, there will be no lane departure alarm recording triggered. Alarm is set to OFF by default.

**Speed:** Set the operating speed value of the Lane departure algorithm. For example, if it is set to 60, the lane departure algorithm can only be started when the vehicle speed is greater than or equal to 60km/h. The default is 60.

**Audio LDWS:** If it is set to "On", audio warning will be sent when the lane departure alarm is triggered; if it is set to Off, no audio warning will be generated when the lane departure alarm is triggered. Audio LDWS is ON by default.

### DMS Algorithm

Driver monitoring system. When the driver is being monitored, the second channel will display the corresponding screen. The following figure shows the default configuration interface:

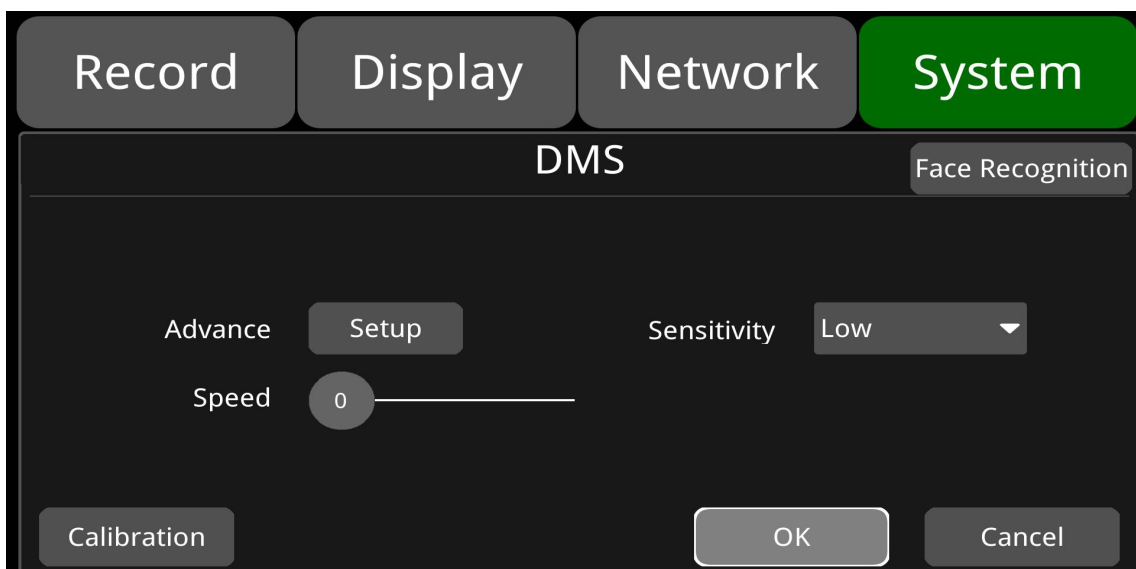



Algo switch **Setup** : DMS detection alarm type selection and default configuration.

| Alarm Type     | To set ON  | To set OFF                                   |
|----------------|--|--|
| DMS_Fatigue    | When the driver's fatigue is detected, an alarm recording will be triggered ,and there will be a voice announcement.               | No fatigue alarm.                            |
| DMS_Distracton | When the driver's distracted is detected, an alarm recording will be triggered, and there will be a voice announcement.            | No distraction alarm.                        |
| DMS_No Driver  | When the driver's absence from the seat is detected, an alarm recording will be triggered, and there will be a voice announcement. | No driver alarm.                             |
| DMS_Smoking    | When the driver's smoking is detected, an alarm recording will be triggered, and there will be a voice announcement.               | No smoking alarm.                            |
| DMS_Calling    | When a phone call of the driver is detected, the alarm recording will be triggered, and there will be a voice announcement.        | No phone call alarm.                         |
| DMS_NoSeatBelt | A "no seat belt" alarm and a voice broadcast will be triggered when the driver is detected not wearing a seat belt.                | No "no seat belt" alarm and voice broadcast. |

|               |  |                                |
|---------------|--|--------------------------------|
| DMS_SunGlass  | An alarm recording will be triggered when the driver is detected wearing sunglasses. | No “wearing sunglasses” alarm. |
| DMS_YAWN      | An alarm recording will be triggered when the driver is detected yawning.            | No yawning alarm.              |
| DMS_NoMask    | An alarm recording will be triggered when the driver is detected not wearing a mask. | No “not wearing a mask” alarm  |
| DMS_NoShelter | An alarm recording will be triggered when the camera is blocked.                     | No camera blocked alarm        |

| Options      | Description   |
|--------------|---|
| Algo Switch  | Algorithm alarm switch.   |
| Audio Switch | Voice alarm switch.   |
| Sensitivity  | Sensitivity level. There are three levels, Low, Medium, and High. The default is Low.   |
| Speed(km/h)  | To set the DMS working speed value. For example, if it is set to 60, the DMS algorithm can only be activated when the vehicle speed is greater than or equal to 60. The default is 0. |

The default values for the DMS parameters are as follows:

| Alarm type      | Default |
|-----------------|---------|
| DMS_Fatigue     | On      |
| DMS_Distraction | On      |
| DMS_No Driver   | Off     |
| DMS_Smoking     | On      |
| DMS_Calling     | On      |
| DMS_NOSeatBelt  | Off     |
| DMS_SunGlass    | Off     |
| DMS_YAWN        | On      |
| DMS_NoMask      | Off     |
| DMS_Shelter     | On      |

|                      |   |
|----------------------|---|
| Sensitivity          | Low   |
| DMS Work Speed(km/h) | 0   |
| Audio Switch         | On (Exception: Off for DMS_NOSeatBelt/DMS_NoMask) |

| Alarm Type  | Alarm Duration/Threshold | Min. | Max. | Default |
|-------------|--------------------------|------|------|---------|
| Fatigue     | Time (s)                 | 1    | 6    | 3       |
|             | Threshold                | 1    | 99   | 30      |
| Distraction | Time (s)                 | 1    | 9    | 5       |
|             | Threshold                | 1    | 99   | 35      |
| NoDriver    | Time (s)                 | 1    | 30   | 1       |
|             | Threshold                | /    | /    | /       |
| Smoking     | Time (s)                 | 1    | 20   | 2       |
|             | Threshold                | 1    | 99   | 50      |
| Calling     | Time (s)                 | 1    | 5    | 3       |
|             | Threshold                | 1    | 99   | 60      |
| Times (s)   | Time (s)                 | 1    | 30   | 10      |
|             | Threshold                | 1    | 99   | 50      |
| SunGlass    | Time (s)                 | 1    | 30   | 10      |
|             | Threshold                | /    | /    | /       |
| YAWN        | Time (s)                 | 1    | 5    | 5       |
|             | Threshold                | /    | /    | /       |
| NoMask      | Time (s)                 | 1    | 15   | 10      |
|             | Threshold                | /    | /    | /       |
| Shelter     | Time (s)                 | 1    | 30   | 5       |
|             | Threshold                | /    | /    | /       |

#### DMS Installation:

- DMS should be installed in a proper location. It is required to install it on the driver's console at a distance of 0.8~1.2M from the driver and at an approximate angle of +/-30 degrees from the driver's front view, as shown in the figure below. Installation and calibration need to be done simultaneously, so it is recommended to have a manager present to adjust, calibrate the device and guide the driver during the relevant operations.



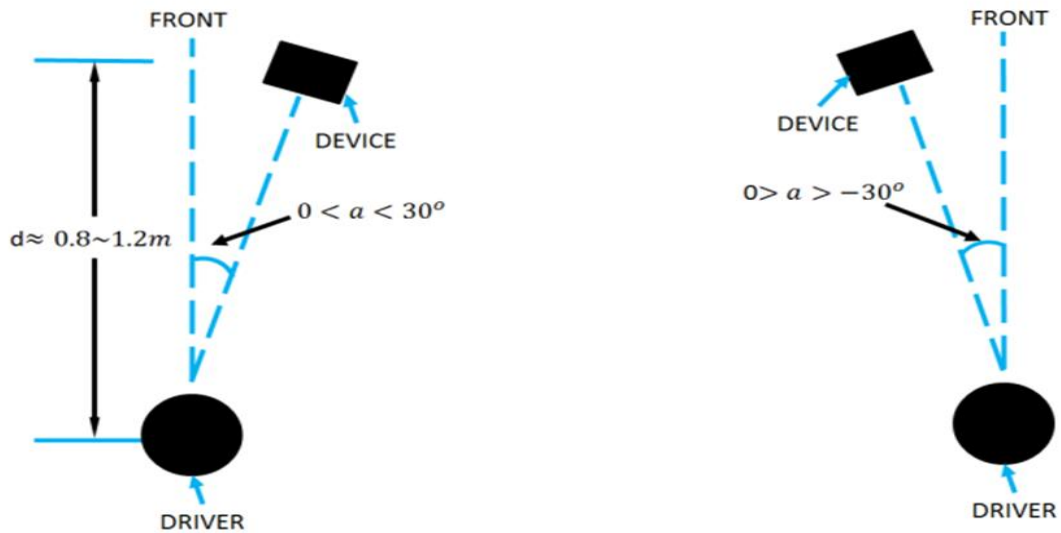

**Calibration:** Parameter calibration. Calibrate your face by aligning it with the square blue (default) calibration box displayed on the screen. Once aligned, a green box will appear at the position of the face, and then click the Start button to proceed. 2~3s later, a pop-up box will appear with the message “Calibration successful!”, accompanied by voice prompts. To exit the calibration interface, simply click the OK button in the pop-up box. As shown below:

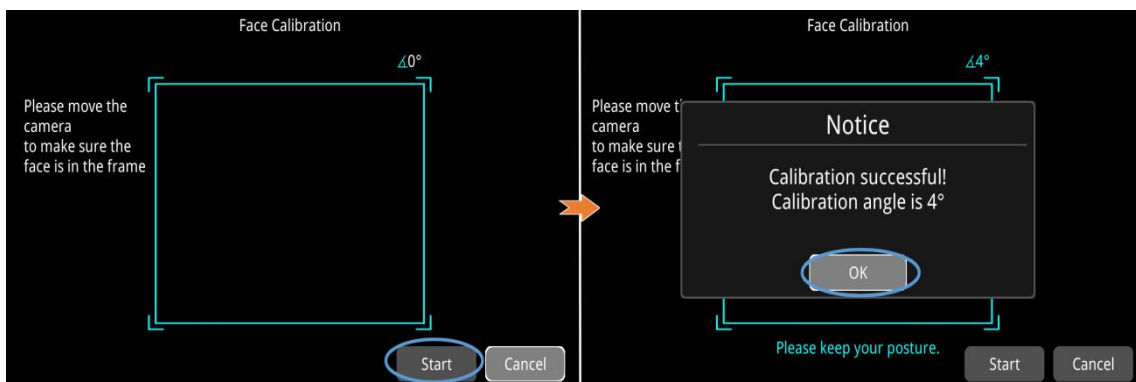

Align your face with the calibration box displayed on the screen, and then click the Start button to proceed. If your face moves out of the box during calibration, the box will turn yellow. After 2~3s, a pop-up box will appear indicating “Calibration failed!”. Click the OK button in the pop-up box to restart the calibration. As shown below:

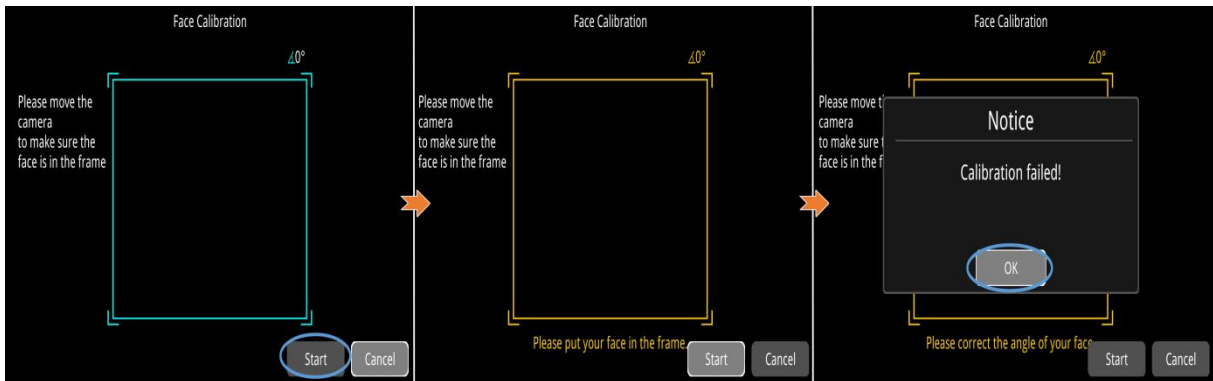

Align your face with the calibration box displayed on the screen, and then click the Start button to proceed. If the face deflects from side to side during calibration, when the angle exceeds the range of [-30, 30], the box will turn red, and the voice prompts will indicate “too left” or “too right”. After 2~3s, a pop-up box will appear indicating “Calibration failed”. Click the OK button in the pop-up box to restart the calibration. As shown below:

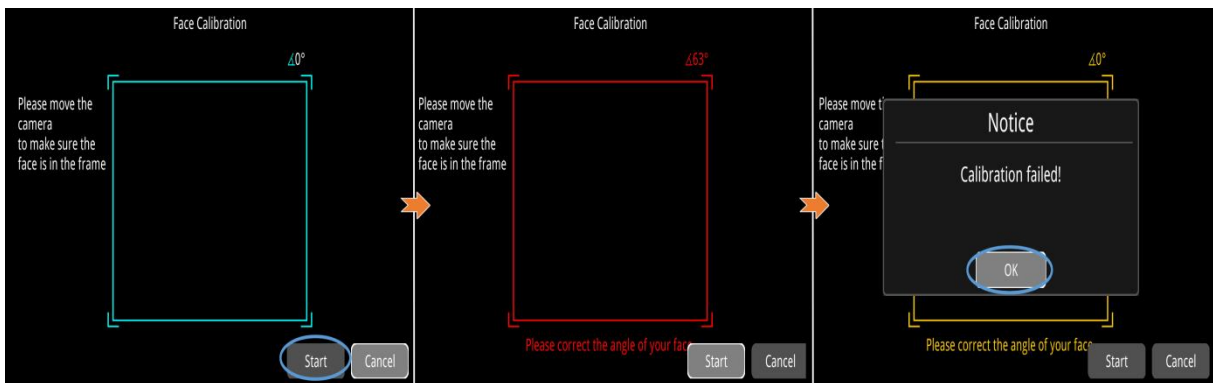

After a calibration failure, simply click the Start button again to initiate the calibration process.

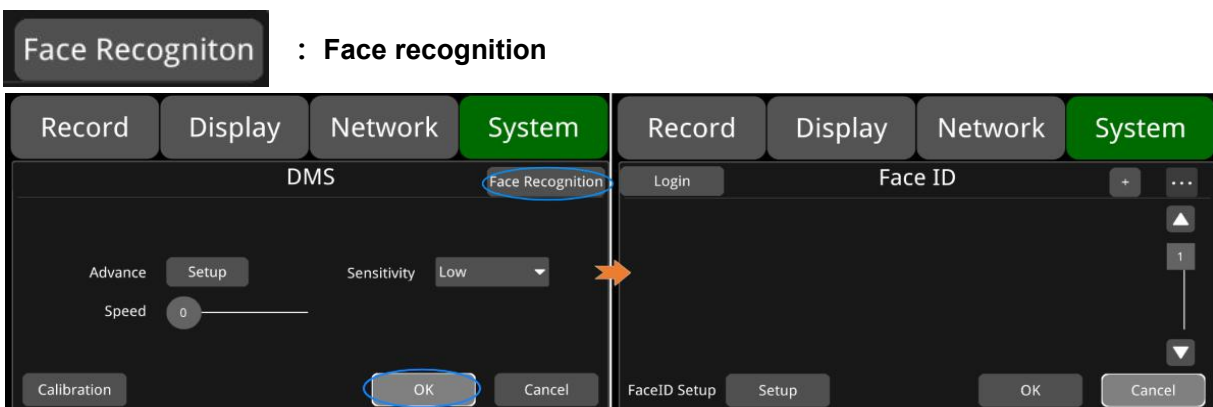

+: Add a human face, as shown in the figure below. Click OK after entering the name, and aim your face at the camera. Click the Start button, and move your face up, down, left and right to input the data. Then a window will pop up to notify the success or failure of input with a voice message.

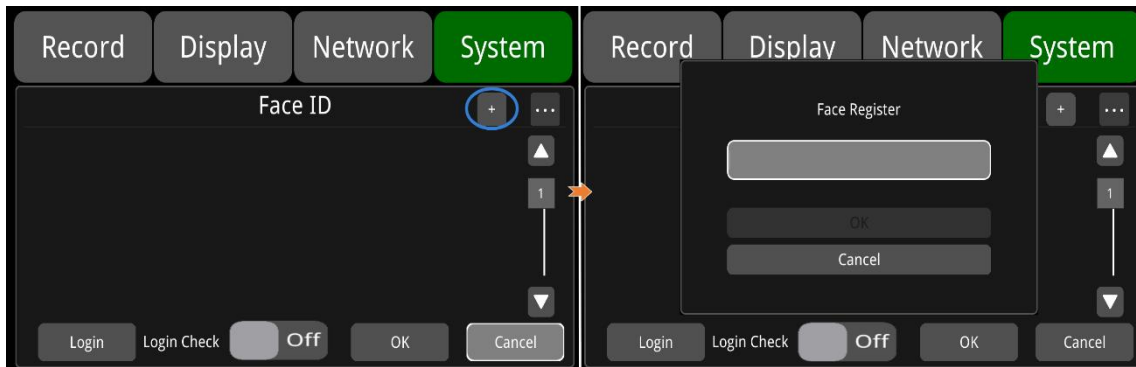

...: Import, export and delete functions. As shown in the figure below, check the imported face photo and click Import/Export/Del to import, export or delete the selected photo. The exported files are stored under the "faceID" path on the disk.

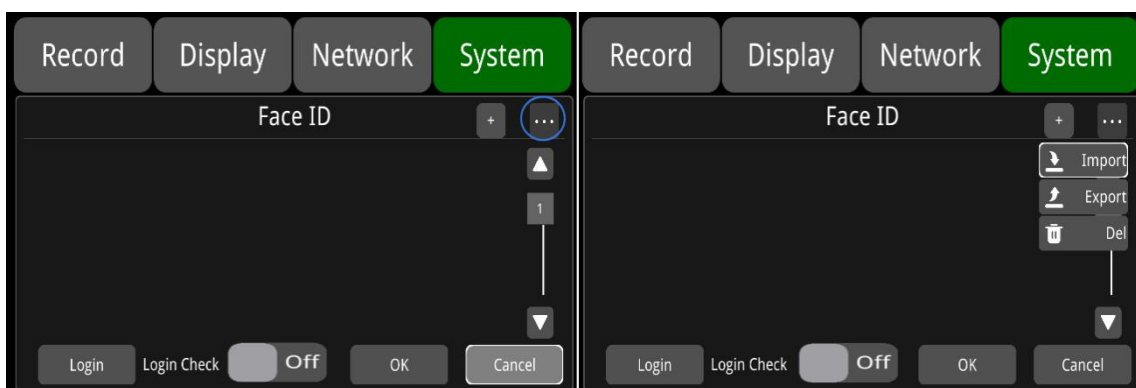

**Login:** Click to log in through face recognition.

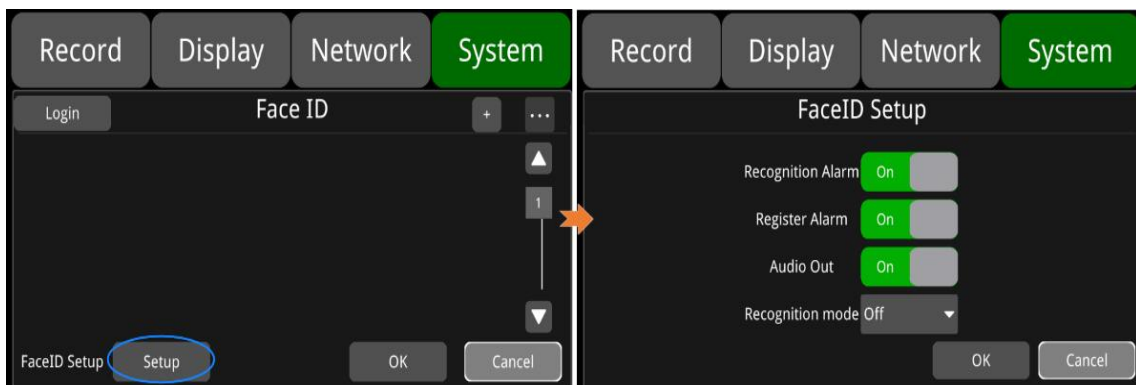

**Recognition Alarm:** Face recognition alarm. It is On by default.

**Register Alarm:** Face registration alarm. It is ON by default.

**Audio Out:** Voice alarm switch. It is ON by default.

**Recognition mode:**

Face recognition mode. There are three available options.

**Power On:** This option enables automatic face recognition when the device is powered on. Each time you turn on the device, it will initiate face verification and provide a voice prompt saying "again to login". When you position your face in front of the camera, there will be a prompt stating "login success". If no face is detected or a new face is detected, there will be a voice prompt saying "login fail". This prompt is only given once when the device is powered on.

**Auto:** This option allows face recognition to occur every 5 minutes automatically. The device will initiate face verification at regular intervals without any manual intervention.

**Off:** This option disables the face verification feature. No face recognition will be performed. It is Off by default.

## BSD Algorithm

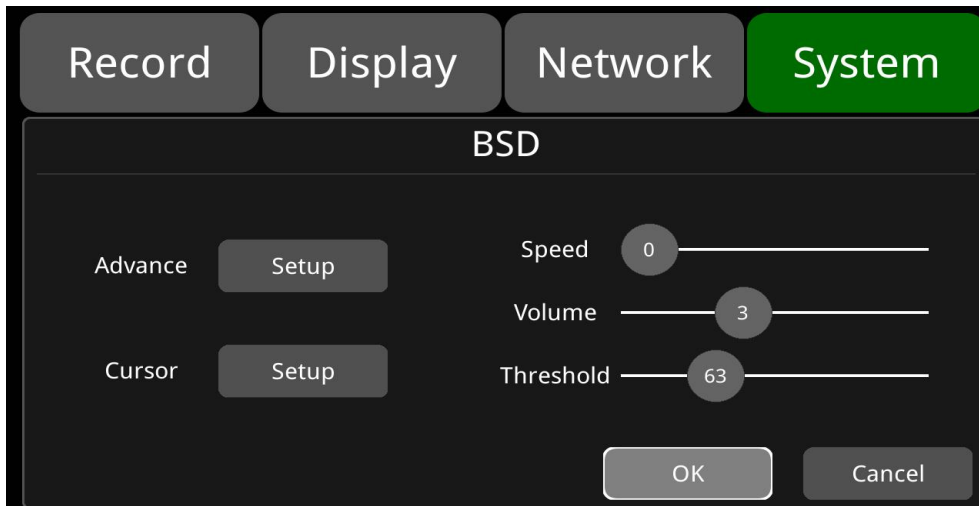

**Advance:** Set the range covered by the BSD algorithm and the related alarm settings as shown below:

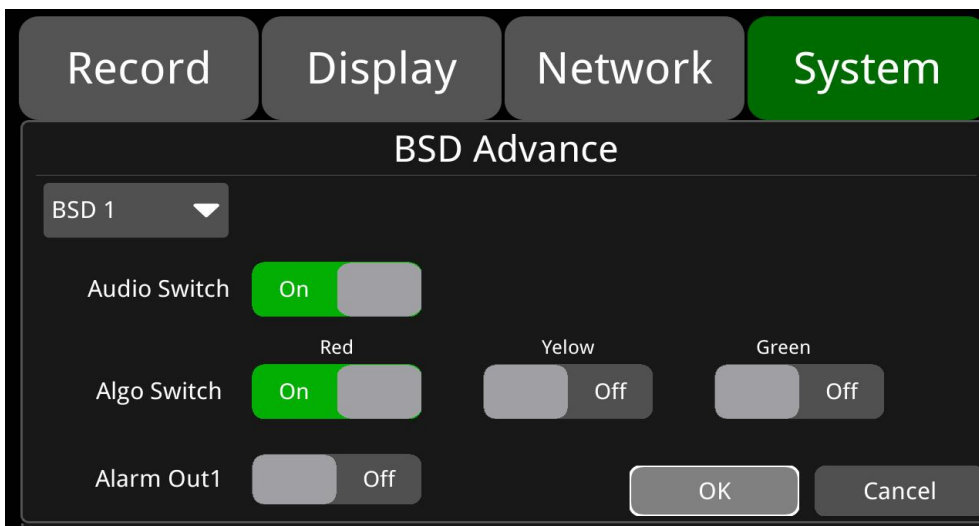

**Audio Switch:** Video alarm switch. Set to "On" for alarm sound output, off for none. The default is ON.

**Algo Switch:** Alarm zone switch. There are three optional switches, red, yellow and green. Red is ON by default.

**Alarm Out1:** Level output switch. If it is turned on, Alarm Out1 will output a high level after a BSD alarm is triggered.

**Speed:** Set the speed threshold for BSD function. When set to 5, the BSD algorithm will activate only when pedestrians are walking at a speed of 5km/h or higher. The default value is 0.

**Volume:** Adjust the volume of the audible and visual alarm. The default value is 3.

**Threshold:** Pedestrian detection and alarm precision selection.

|           | Min. | Max. | Default |
|-----------|------|------|---------|
| Speed     | 0    | 100  | 0       |
| Volume    | 0    | 8    | 3       |
| Threshold | 50   | 99   | 63      |

**Cursor:** It is ON by default. The figure below shows the “On” state.

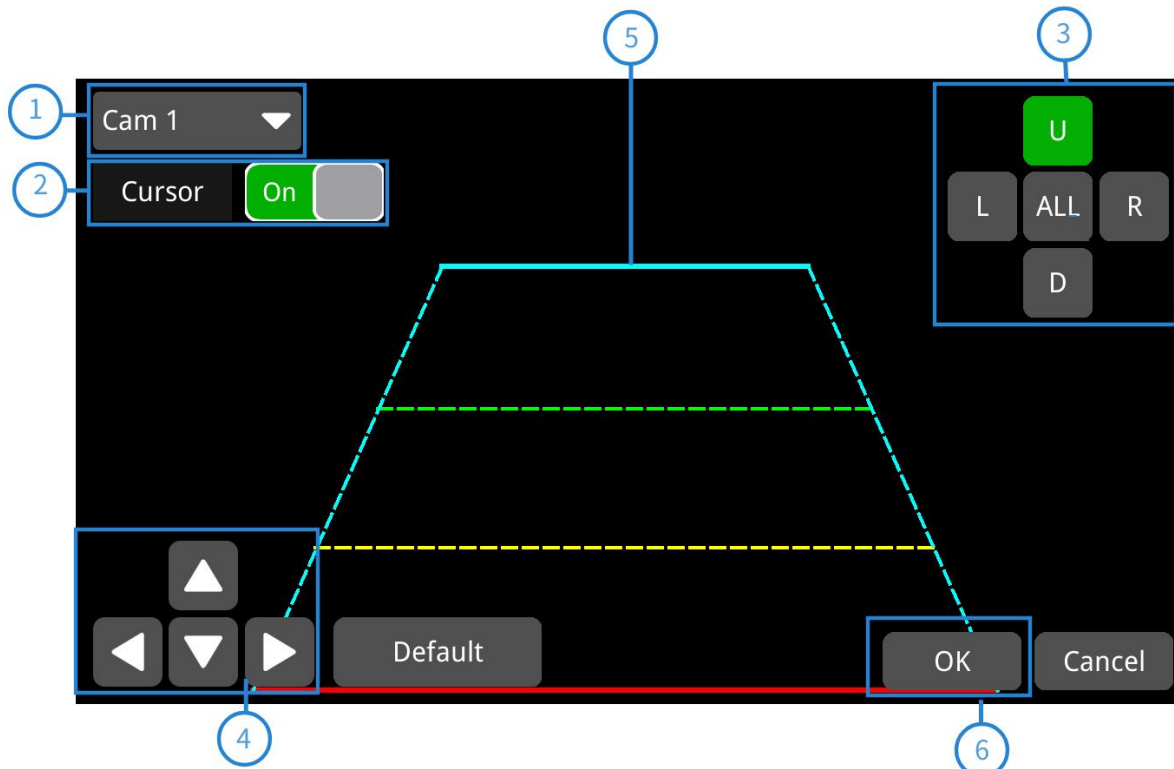

- ① Camera name of the alarm-triggered channel.
- ② Touch this button to turn on/off the corresponding cursor.
- ③ Line selecting: There are five lines to be selected. Line U (up), Line D (down), Line L (left), Line R (right) and ALL. The button turns green if selected. You can quickly operate with “1, 2, 3, 4, 5” on the remote control.
- ④ There are 4 direction to adjust the shape of the cursor, Up, Down, Left and Right.  
 If Line U (the green one) or Line D (the red one) is selected, the selected line can be moved as a whole with these direction buttons.  
 If Line L or Line R is selected, the top point of the selected line can be moved to left or right with Direction Down or Direction Up, and the bottom point of the selected line can be moved to left or right with Direction Left or Direction Right.  
 If ALL is selected, all the lines can be moved as a whole in these four directions.
- ⑤ Lines of cursor: The selected one will be thickened for three times. The middle two lines will not be processed.
- ⑥ Touch OK to save the settings and exit. Cancel to exit without saving any settings.

## APC Algorithm

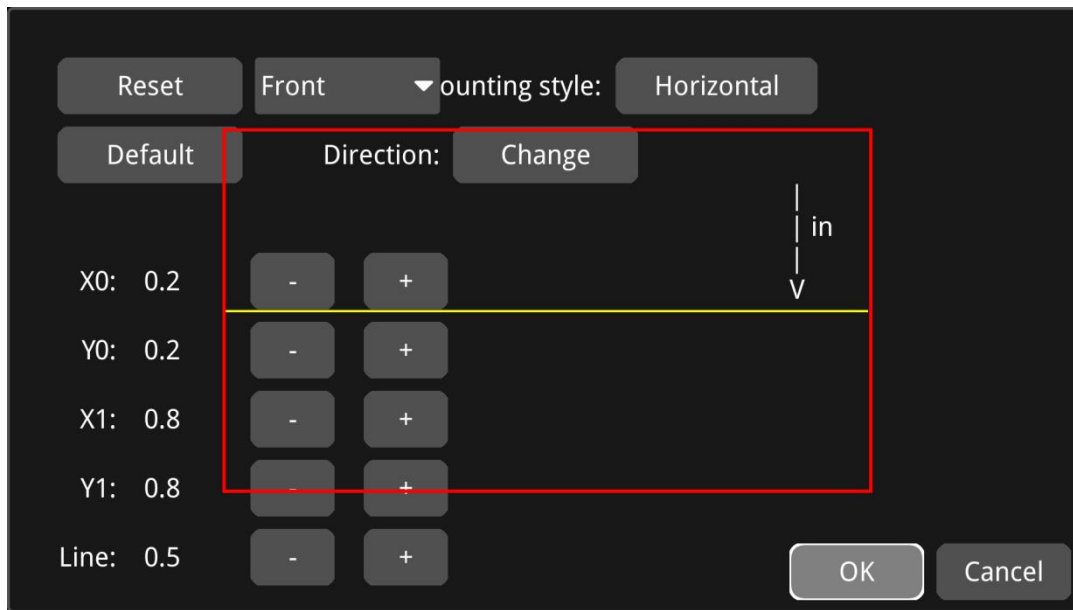

**Reset:** Click to revert to the previous settings.

**Default:** Click to revert to the default settings.

**Counting style:** To choose the direction of the yellow line - a line used to detect passengers entering and exiting, in the detection frame. If Horizontal is selected, it will become a horizontal line, which detects passengers entering and exiting the vehicle in an up-and-down direction within the detection frame. Similarly, if Vertical is selected, it will become a vertical line detecting passengers entering and exiting the vehicle in a left-and-right direction within the detection frame.

**Direction:** Select the direction in which you want to detect entry and exit.

**X0:** Adjust the value for the position of the left border. "-" is to move left, and "+" is to move right. The default is 0.2.

**Y0:** Adjust the value for the position of the top border. "-" is to move up, and "+" is to move down. The default is 0.2.

**X1:** Adjust the value for the position of the right border. "-" is to move left, and "+" is to move right. The default is 0.8.

**Y1:** Adjust the value for the position of the bottom border. "-" is to move up, and "+" is to move down. The default is 0.8.

## 11.11 System Info



System Info: Software version number.

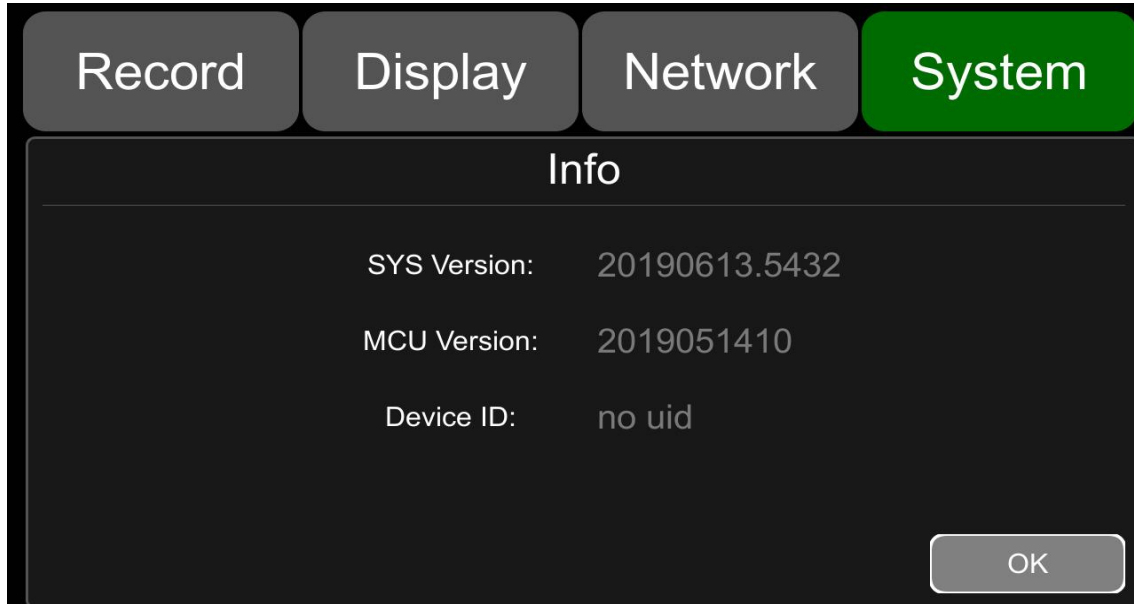

## 12 FAQ

### 1) The System Can't Start up?

Check the power connection. Please follow the steps below to check the power connection:

- ① Check the input power: if the power wire is correctly connected, if the ground wire is connected to the battery, and if the fuse on the power wire is in good condition.
- ② Check if the voltage of the ACC signal wire is higher than 6V.
- ③ Check if the input voltage of the device exceeds the shutdown voltage set on the device's screen.

### 2) The Device Keeps Restarting?

Please follow the steps below to check:

- ① Check if the supply voltage of DVR is insufficient. If it is lower than the start-up voltage, the device would restart repeatedly.
- ② Restart the device to see if it will work properly.

### 3) Unable to Recognize Disks?

- ① Check if the disk is in good condition and ensure that it is properly installed with secure contact.
- ② The disk has been formatted by DVR.
- ③ Restart the device to see if it will work properly.

#### 4) Unable to Recognize Cameras?

- ① Make sure the camera is good and properly connected.
- ② Reconnect all wires (e.g. extended wires) between cameras and the device.
- ③ Restart-the device to see if it will work properly.

#### 5) GPS Anomaly?

Check if the GPS antenna is properly installed.

## 13 APPENDIX









### APPENDIX I : Abbreviation & Description

|          |                                     |        |                            |
|----------|-------------------------------------|--------|----------------------------|
| Rec.     | Record                              | LED    | Light Emitting Diode       |
| G-sensor | Accelerometer sensor                | SD     | Secure Digital Memory Card |
| GPS      | Global Positioning System           | USB    | Universal Serial Bus       |
| Wi-Fi    | Wireless-Fidelity                   | ALM    | Alarm                      |
| Cam      | Camera                              | VLOSS  | Video Loss                 |
| AVI      | Audio Video Interleaved             | COMM   | Communication              |
| OSD      | On-Screen Display                   | ERR    | Error                      |
| APN      | Access Point Name                   | MEM    | Memory                     |
| DHCP     | Dynamic Host Configuration Protocol | MMSHOW | Media Player               |
| SSID     | Service Set Identifier              | FTP    | File Transfer Protocol     |
| IP       | Internet Protocol                   | DVR    | Digital Video Recorder     |
| MAC      | Media Address Control               | IR     | Infrared Radiation         |
| RSSI     | Received Signal Strength Indication | SYS    | System                     |
| SSD      | Solid State Drive                   | DST    | Daylight Saving Time       |







## APPENDIX II : Accessories

Standard Table:

| Parts  | Quantity | Description        | Parts  | Quantity | Description                                     |
|--|----------|--------------------|--|----------|---|
|   | 1.       | 9 PIN power cable  |  | 1        | 10 PIN alarm wire                               |
|   | 1        | 5 PIN CAN BUS wire |  | 1        | 232&485<br>8 PIN to 7-wire<br>cable             |
|   | 1        | 6 PIN to RJ45      |  | 1        | Four-in-one antenna<br>(2G-3G-4G-Wi-Fi-G<br>PS) |
|  | 1        | Remote control     |  | 1        | DVR lock keys                                   |

Optional Accessories Table:

| Parts   | Quantity | Description                 | Parts   | Quantity | Description                       |
|---|----------|-----------------------------|---|----------|-----------------------------------|
|  | 1        | VGA, 10 PIN to 15 PIN cable |  | 1        | Adaptor cable for<br>panic button |
|  | 1        | SSD OUT<br>adaptor cable    |  | 1        | 10-inch touch<br>screen monitor   |
|  | 1        | Panic button                |   |          |                                   |

## APPENDIX III: Compatibility Storage List

### SATA 3.0 SSD

| Name      | Description                      |
|-----------|----------------------------------|
| SSD 32GB  | MLC, TS32GSSD420I, -45°C~+85°C   |
| SSD 64GB  | MLC, TS64GSSD420I, -45°C~+85°C   |
| SSD 128GB | MLC, TS128GSSD420I, -45°C~+85°C  |
| SSD 256GB | MLC, TS256GSSD420I, -45°C~+85°C  |
| SSD 512GB | MLC, TS512GSSD420I, -45°C~+85°C  |
| SSD 1TB   | MLC, TS1TSSD420I, -45°C~+85°C    |
| SSD 128GB | 3D TLC, TS128GSSD450K, 0°C~+70°C |
| SSD 256GB | 3D TLC, TS256GSSD450K, 0°C~+70°C |
| SSD 512GB | 3D TLC, TS512GSSD450K, 0°C~+70°C |
| SSD 1TB   | 3D TLC, TS1TSSD450K, 0°C~+70°C   |

### SD Card

| Item Name         | Description                                    |
|-------------------|--|
| 32GB SD Card      | 32G, MLC, NCSXDAB-032G, Longsys, -25°C~+85°C   |
| 64GB SD Card      | 64G, MLC, NCSXJAB-064G , Longsys, -25°C~+85°C  |
| 128GB SD Card     | 128G, MLC, NCSXJAB-128G , Longsys, -25°C~+85°C |
| 64GB microSD Card | 64G, MLC, NCIXJBB-064G                         |

**AMERICAN BUS VIDEO INC.**

**Toll-Free 866.468.8042**

**Fax: 770.887.5944**

**AmericanBusVideo.com**

**SchoolBusCamera.com**

**VehicleVideoCameras.com**

**35+ Years of Mobile Digital Sales & Service Experience**